

ACE/
ACE ACOUSTIC/
TRACK 48V/
TWENTY/
MAYA_MICRO/

ACE_002

ACE ACOUSTIC_014

TRACK 48V_030

TWENTY_076

MAYA_MICRO_096

PAN

ACE

COLLECTION



IT_ ACE, una proposta in linea con le ultime tendenze del mercato: l'ottimale ricerca di equilibrio tra efficienza ed estetica. Forme semplici si fondono con nuovi standard tecnologici. ACE ha caratteristiche innovative, finiture curate e colorazioni attuali. Si installa a sospensione, a parete e soffitto ed è associabile ad altre componenti che ampliano il raggio d'impiego dell'apparecchio. Due le dimensioni, con schede Led di potenza diversa, proposte con finiture nero opaco, oro e bronzo. Disponibili soluzioni On/Off e dimmerabili.

EN_ ACE responds to market trends in the optimal pursuit of balance between efficiency, aesthetics, and technology. Simple forms merge with the most advanced electronic offerings for contemporary lighting. ACE boasts innovative features, refined and current finishes. It can be installed as a suspension, wall, or ceiling fixture and can be combined with other components to expand its range of applications. It comes in two sizes, with Led boards of different power, available in matte black, gold, and bronze finishes. Both On/Off and dimmable solutions are available.



ACE

**NERO/
ORO/
BRONZO/**

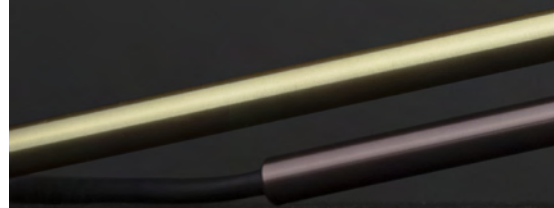



ACE



ACE_Led

IT_ACE Led è realizzato in alluminio con lavorazione CNC. Le finiture, con trattamento galvanico del metallo, sono nero opaco, oro e bronzo. Due le misure del gruppo Led con schede da 9,5W e 12W, disponibili nei toni colore 2700, 3000 e 4000K. Diffusore satinato antiabbagliamento. L'apparecchio si configura come sospensione oppure installazione da parete-soffitto. Diverse le opzioni per l'alimentazione; si sceglie tra versioni On/Off, DALI, Push.

EN_ACE Led is made of CNC aluminum work. The finishes, with galvanic treatment, are matt black, gold, bronze. Two sizes of the Led 9,5W and 12W boards, available in color tones 2700, 3000 and 4000K. Anti-glare satin diffuser. The luminaire can be suspended or wall-ceiling mounted. Several options for power: On/Off, DALI, Push.

ACE_Glass

IT_Una sfera in vetro satinato, diametro 15 cm è l'elemento caratterizzante della versione ACE Glass. Si valorizza ulteriormente la qualità della scheda Led integrata (160lm/W). Oltre ad un marcato effetto estetico viene massimizzata la qualità e la morbidezza del flusso luminoso emesso. Questa soluzione è disponibile per installazione a sospensione oppure a parete - soffitto.

EN_A satin glass sphere, diameter 15cm is the basic element of the ACE Glass version. The quality of the integrated Led board (160lm/W) is further enhanced. In addition to a marked aesthetic effect is maximized the quality and softness of lumen flux. This solution is available for suspended or wall - ceiling installation.





**SOSPENSIONE/
SOFFITTO/
PARETE/
9,5 W/
12 W/**

ACE



SOSPENSIONE



ACE_Sospensione

LED



Power	Lumen output	Code to complete *
9,5 W	700 lm	BA-SB ■ ▲
◆ 350mA IP20		CRI>80 RG0 SCDM<3 - UP to 73 lm/W L80/B20 60.000 h. Lumen output values: luminaire luminous flux at 4000 K

12 W	1050 lm	BA-SC ■ ▲
◆ 400mA IP20		CRI>80 RG0 SCDM<3 - UP to 87 lm/W L80/B20 60.000 h. Lumen output values: luminaire luminous flux at 4000 K

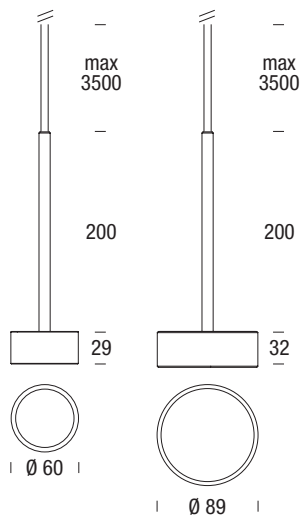

* Select your option

Colour		CCT	
Nero	B	2700 K	1
Oro	S	3000 K	2
Bronzo	Z	4000 K	3

ALIMENTAZIONE

	Description	Code to complete *
	⚡ Rosone LED, 9,5 W 220-240Vac, alimentatore incluso	BSS02AB ● □
	LED, 12 W BSS02AC ● □	
	□ Incasso LED, 9,5 W 220-240Vac, alimentatore incluso	BSS04AB ● □
	LED, 12 W BSS04AC ● □	

* Select your option

Colour		Control	
Bianco	W	On/Off	NF
Nero	B	DALI	DA
		Push	PU

ACE_Sospensione

GLASS



Power	Lumen output	Code to complete *
9,5 W	560 lm	AG-S ■ ▲

◆ 350mA | IP20

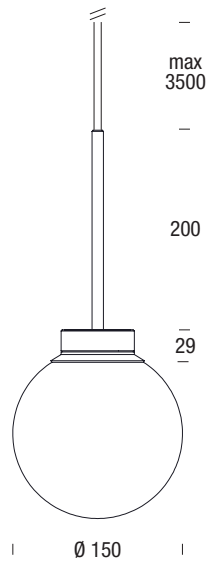

CRI>80 | RG0 | SCDM<3 - UP to 59 lm/W | L80/B20 60.000 h.
Lumen output values: luminaire luminous flux at 4000 K



* Select your option

Colour		CCT	
Nero	B	2700 K	1
		3000 K	2
		4000 K	3

ALIMENTAZIONE

	Description	Code to complete *
	Rosone LED, 9,5 W 220-240Vac, alimentatore incluso	BSS02AB ● □
	Incasso LED, 9,5 W 220-240Vac, alimentatore incluso	BSS04AB ● □

* Select your option

Colour		Control	
Bianco	W	On/Off	NF
Nero	B	DALI	DA
		Push	PU



ACE



SOFFITTO / PARETE

ACE_Soffitto / Parete

LED

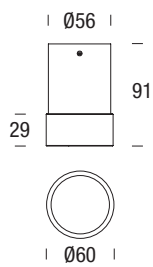

Power	Lumen output	Code to complete *
9,5 W	700 lm	BA-C ■ ▲

⊕ 220÷240Vac | IP20

CRI>80 | RG0 | SCDM<3 - UP to 73 lm/W | L80/B20 60.000 h.
Lumen output values: luminaire luminous flux at 4000 K

* Select your option

Colour		CCT	
Nero	B	2700 K	1
		3000 K	2
		4000 K	3

GLASS

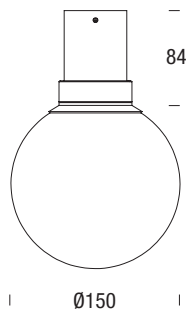

Power	Lumen output	Code to complete *
9,5 W	560 lm	AC-C ■ ▲

⊕ 220÷240Vac | IP20

CRI>80 | RG0 | SCDM<3 - UP to 59 lm/W | L80/B20 60.000 h.
Lumen output values: luminaire luminous flux at 4000 K

* Select your option

Colour		CCT	
Nero	B	2700 K	1
		3000 K	2
		4000 K	3

ACE

ACOUSTIC

IT_ La versione ACOUSTIC integra un elemento con caratteristiche fonoassorbenti al gruppo luce ACE. La calotta, realizzata in polietilene ad alta densità, è adatta a rendere più accogliente l'acustica interna di un ambiente e migliorarne il comfort acustico. Il materiale termoformato è totalmente riciclabile, ecologico, non utilizza sostanze chimiche, collanti e coloranti. Ace ACOUSTIC viene proposta in 3 dimensioni: 45, 60 e 90 cm. Quattro i colori nella gamma: grigio, blu, rosso e verde.



En_ The ACOUSTIC version integrates an element with sound-absorbing characteristics to the ACE light unit. The diffuser, made of high density polyethylene, is suitable to make the interior acoustics of a room more welcoming and improve the acoustic comfort. The thermoformed material is totally recyclable, environmentally friendly, does not use chemicals, adhesives and dyes. Ace ACOUSTIC comes in 3 sizes: 45, 60 and 90 cm. Four colors in the range: gray, red, green and blue.

GRIGIO/
BLU/
ROSSO/
VERDE/







**45 Ø/
60 Ø/
90 Ø/
SOSPENSIONE/
SOFFITTO/
PARETE/**

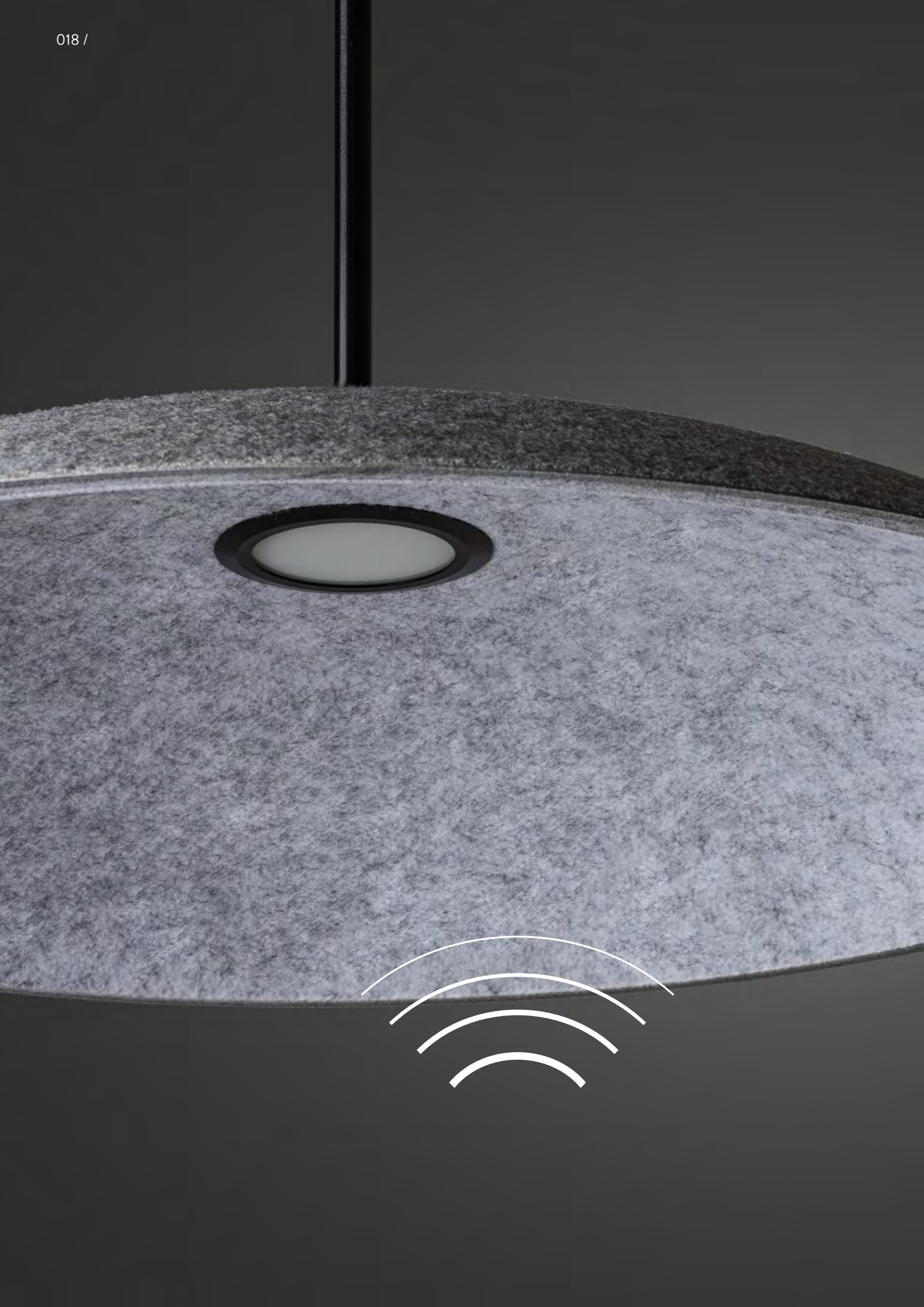

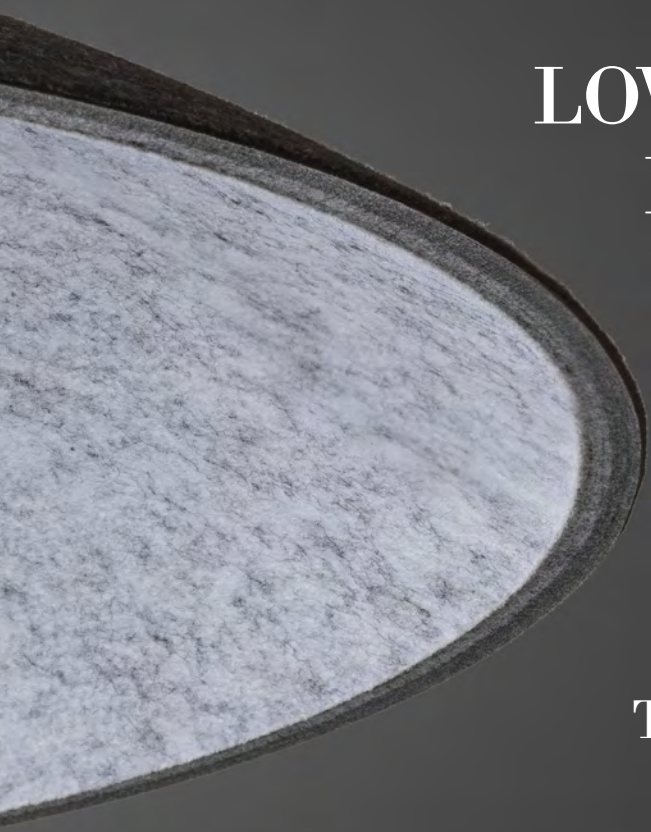

**LOW NOISE,
BETTER
LIVING**

**LA QUALITÀ
ACUSTICA
DELL'AMBIENTE
MIGLIORA LE
TUE GIORNATE**





IT La gamma di ACE_Acoustic non si limita all'utilizzo di scelte tecnologiche avanzate. L'impiego di un portalampade E27, classica montatura "senz'attesa", semplifica l'utilizzo e permette l'utilizzo di lampadine Led nelle diverse forme e colorazioni. La semplicità assoluta incontra la creatività e ne suggerisce l'installazione nei progetti più diversificati. Un rapporto qualità - prezzo ottimale è garanzia di successo per le soluzioni ACE_Acoustic E27.

EN The ACE_Acoustic range is not limited to the use of advanced technological choices. The use of an E27 lampholder, a classic "timeless" fixture, simplifies usage and allows for the use of LED bulbs in various shapes and colors. Absolute simplicity meets creativity and suggests their installation in diverse projects. An excellent quality - price ratio ensures success for ACE_Acoustic E27 solutions.

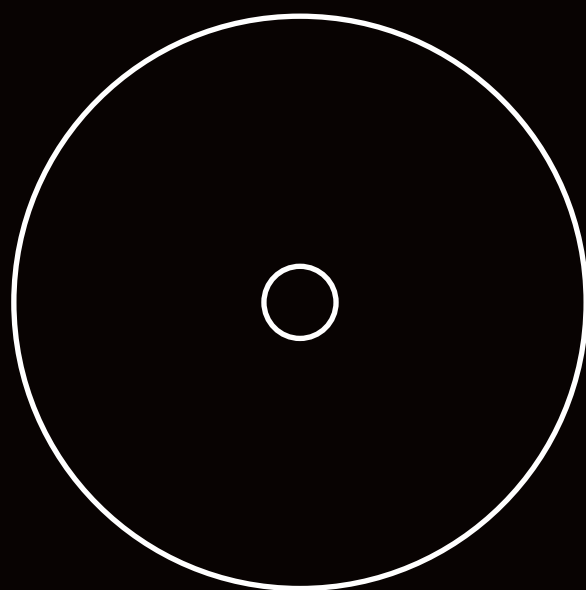
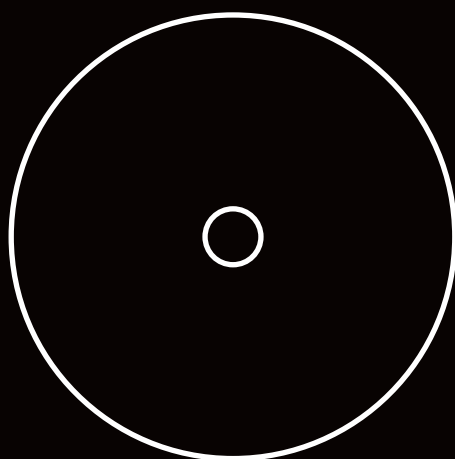
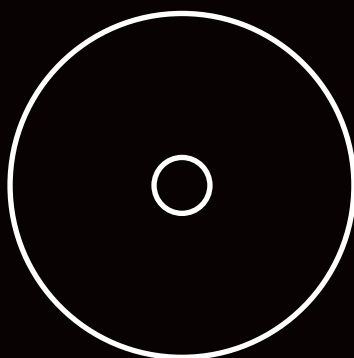

ACE_Acoustic



ACE_Acoustic / Led

IT_La versione Acoustic Led è la sintesi perfetta di estetica e funzionalità. Si configura come sospensione oppure installazione da parete - soffitto e viene proposta con diffusore in 3 misure: 45, 60 e 90 cm. Due le potenze del gruppo luminoso installato: 9,5W e 12W. Apprezzabile l'efficienza e la versatilità della scheda Led (160lm/W) disponibile nelle tonalità colore 2700-3000-4000K.

En_The Acoustic Led version is the perfect synthesis of aesthetics and functionality. It can be configured as a suspension or wall-ceiling installation, available in 3 sizes: 45, 60 and 90 cm. Two powers of the light engine: 9,5W and 12W. Remarkable efficiency and versatility of the Led board (160lm/W) available in color tone 2700-3000-4000K.

ACE_Acoustic / Glass

IT_La versione Acoustic Glass aggiunge un elemento estetico alla versione Led. La sfera in vetro satinato, diametro 15 cm, è un valore aggiunto nella diffusione luminosa dell'apparecchio. L'emissione, pur mantenendo elevata intensità, acquista valori aggiuntivi per qualità e morbidezza.

En_The Acoustic Glass version adds an aesthetic element to the Led version. The satin glass sphere, diameter 15 cm, is an added value in the light diffusion of the luminaire. The emission, while maintaining high intensity, acquires additional values for quality and softness.



ACE_Acoustic / E27

IT_La proposta E27 è il naturale completamento del progetto ACE_Acoustic. La semplicità di un portalampade garantisce al committente la totale libertà nella scelta della sorgente luminosa. Ampio spazio quindi a lampadine Led con colori, forme e misure caratterizzate e caratterizzanti. Ogni installazione viene valorizzata dal componente più particolare ed adatto all'ambiente.

En_E27 proposal is the natural completion of the ACE_Acoustic project. The simplicity of a lamp holder guarantees the customer total freedom in choosing the light source. Large space for Led bulbs with colors, shapes and sizes characterized and characterizing. Each installation is enhanced by the most particular component and suitable for the environment.

ACE_Acoustic_Sospensione

LED



Power	Lumen output	Code to complete *
9,5 W	700 lm	AA-SB ■ ▲
◆ 350mA IP20		CRI>80 RG0 SCDM<3 - UP to 73 lm/W L80/B20 60.000 h. Lumen output values: luminaire luminous flux at 4000 K
12 W	1050 lm	AA-SC ■ ▲
◆ 400mA IP20		CRI>80 RG0 SCDM<3 - UP to 87 lm/W L80/B20 60.000 h. Lumen output values: luminaire luminous flux at 4000 K

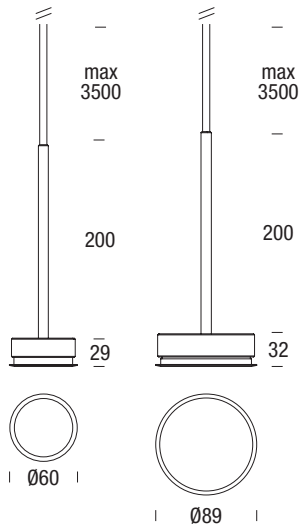

ALIMENTAZIONE

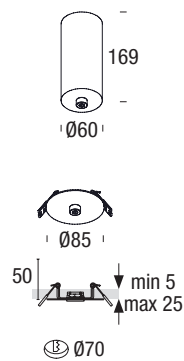

Description	Code to complete *
⊕ Rosone LED, 9,5 W 220-240Vac, alimentatore incluso	BSS02AB ● □
LED, 12 W	BSS02AC ● □
□ Incasso LED, 9,5 W 220-240Vac, alimentatore incluso	BSS04AB ● □
LED, 12 W	BSS04AC ● □

* Select your option

Colour	Control
Bianco	On/Off
Nero	DALI
	Push

CALOTTA



Description	Code to complete *
Calotta	○ 450_H.80 (only: 9,5 W) BSS01A ●●
	○ 600_H.154 (only: 9,5 W) BSS01B ●●
	○ 900_H.248 (only: 12 W) BSS01C ●●

* Select your option

Colour	
Grigio / Grey	G
Blu / Blue	B
Rosso / Red	R
Verde / Green	Y

ACE_Acoustic_Sospensione

GLASS



Power	Lumen output	Code to complete *
9,5 W	560 lm	AC-S ■ ▲
◆ 350mA IP20		CRI>80 RG0 SCDM<3 - UP to 59 lm/W L80/B20 60.000 h. Lumen output values: luminaire luminous flux at 4000 K

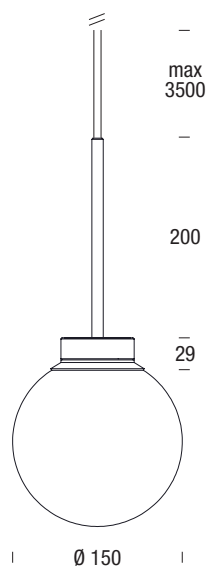

ALIMENTAZIONE

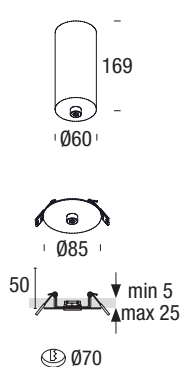

Description	Code to complete *
⊕ Rosone LED, 9,5 W 220-240Vac, alimentatore incluso	BSS02AB ● □
□ Incasso LED, 9,5 W 220-240Vac, alimentatore incluso	BSS04AB ● □

* Select your option

Colour	Control
Bianco	On/Off
Nero	DALI
	Push

CALOTTA

Description	Code to complete *
Calotta	Ø 450_H.80
	Ø 600_H.154



* Select your option

Colour	
Grigio / Grey	G
Blu / Blue	B
Rosso / Red	R
Verde / Green	Y

ACE_Acoustic_Sospensione

E27





Socket	Power	Code
E27	1x Max 40 W	AB-S

220=240Vac I IP20

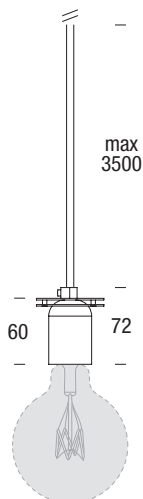
Lamp not included





ALIMENTAZIONE

	Description	Code
	Rosone 220-240Vac	BSS02BB
	Incasto 220-240Vac	BSS04BW
		BSS04BB

CALOTTA



Description	Code to complete *
Calotta Ø 450_H.80	BSS01A 
Ø 600_H.154	BSS01B 

* Select your option

Colour	
Grigio / Grey	G
Blu / Blue	B
Rosso / Red	R
Verde / Green	Y

ACE_Acoustic_Soffitto / Parete

LED



Power	Lumen output	Code to complete *
9,5 W On/Off	700 lm	AA-C ■ △

⊕ 220÷240Vac | IP20

CRI>80 | RG0 | SCDM<3 - UP to 73 lm/W | L80/B20 60.000 h.
Lumen output values: luminaire luminous flux at 4000 K

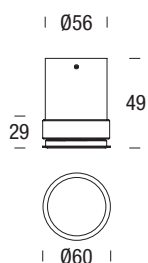

* Select your option

Colour		CCT	
Nero	B	2700 K	1
		3000 K	2
		4000 K	3

CALOTTA



Description	Code to complete *
Calotta Ø 450_H.80	BSS01A ❖❖
Ø 600_H.154	BSS01B ❖❖

* Select your option

Colour	
Grigio / Grey	G
Blu / Blue	B
Rosso / Red	R
Verde / Green	Y

ACE_Acoustic_Soffitto / Parete

GLASS



Power	Lumen output	Code to complete *
9,5 W On/Off	560 lm	AC-C ■ ▲

⊕ 220=240Vac | IP20

CRI>80 | RG0 | SCDM<3 - UP to 59 lm/W | L80/B20 60.000 h.
Lumen output values: luminaire luminous flux at 4000 K

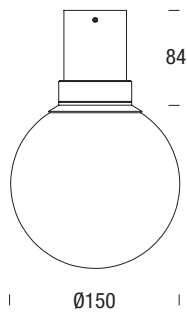

* Select your option

Colour		CCT	
Nero	B	2700 K	1
		3000 K	2
		4000 K	3

CALOTTA

Description	Code to complete *
Calotta Ø 450_H.80	BSS01A ❖❖
Ø 600_H.154	BSS01B ❖❖



* Select your option

Colour	
Grigio / Grey	G
Blu / Blue	B
Rosso / Red	R
Verde / Green	Y



TRACK 48V

COLLECTION

SUPERFICIE_Small
SOSPENSIONE_Small

1000 mm
2000 mm
3000 mm

Bianco / Nero

SUPERFICIE_Deep
SOSPENSIONE_Deep

1000 mm
2000 mm
3000 mm

Bianco / Nero



SOSPENSIONE_Up/Down

1000 mm
2000 mm
3000 mm

Bianco / Nero

INCASSO_Trimless

1000 mm
2000 mm
3000 mm

Nero

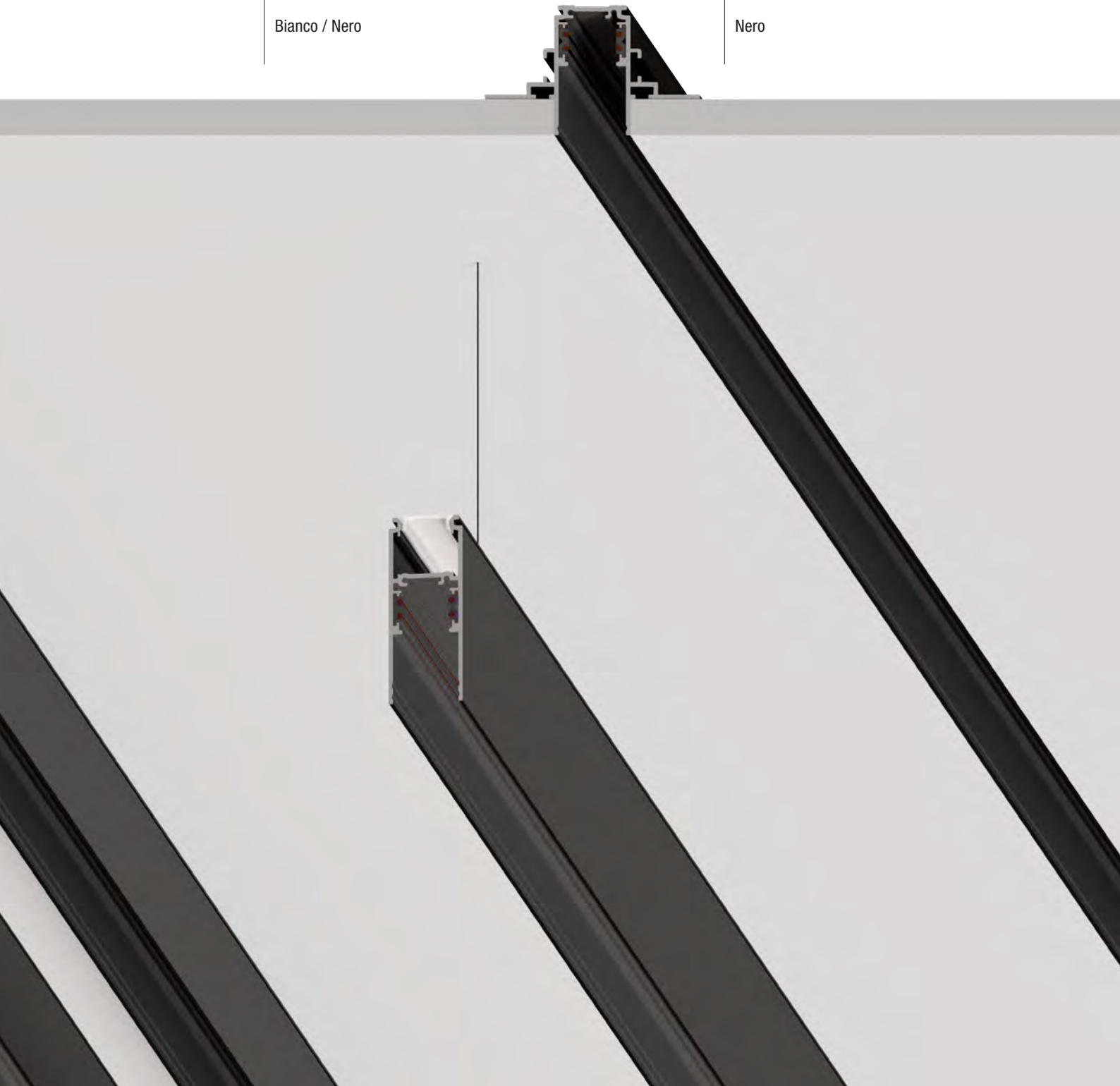





TRACK 48V

COLLECTION

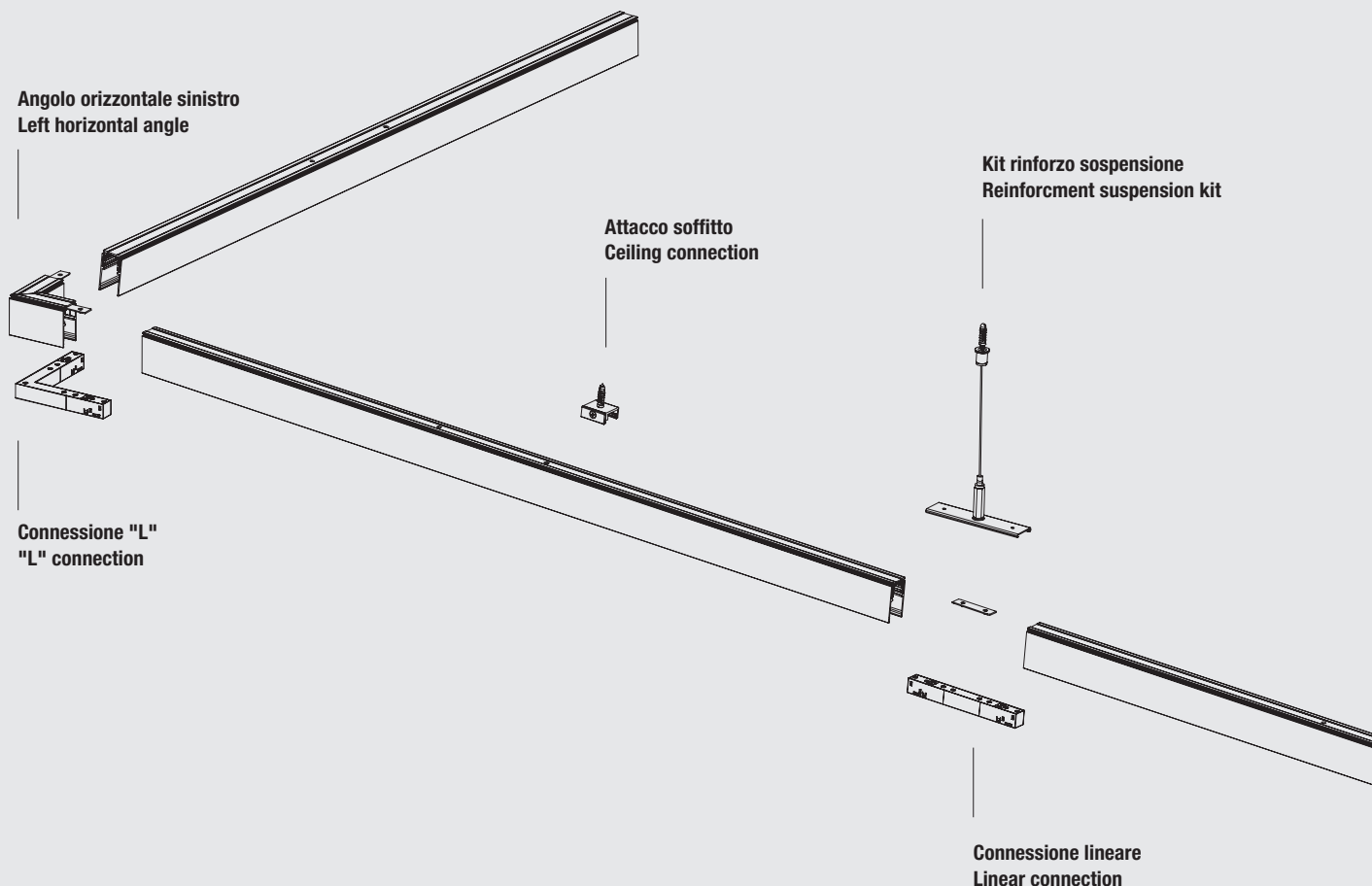

IT_ La linea TRACK 48V offre un programma completo di binari in bassissima tensione per uso interno. Ogni binario, realizzato in estrusione di alluminio, è disponibile nei colori bianco e nero. Al suo interno, trovano spazio 4 conduttori in rame: due linee sono dedicate all'alimentazione, 2 linee si utilizzano per i dati. Diverse le tipologie d'installazione: Soffitto-Parete, Sospensione ed Incasso. La gamma dei binari si differenzia per estetica e per tipologia d'installazione: Slim, minimale e poco invasivo; Deep, capace di nascondere completamente ogni elemento tecnico; Up/Down con possibilità d'emissione alto-basso. La versione Incasso, con sezione appofondita, nasconde completamente componenti tecnologiche e driver. Ogni tipologia d'installazione ha una serie di accessori che consentono lo sviluppo di linee, angoli e forme secondo necessità. Il sistema si completa con la sezione alimentatori: si può scegliere tra alimentazione diretta sul binario (con driver dedicato On/Off o DALI) oppure con driver remoto.

EN_ The TRACK 48V line offers a complete program of low-voltage tracks for indoor use. Each track, made in aluminum extrusion, is available in white and black colors. Inside, there are 4 copper conductors: two lines are dedicated to power supply, two lines are used for data. There are various installation types: Ceiling-Wall, Suspension, and Recessed. The track range varies in aesthetics and installation type: Slim, minimal, and discrete; Deep, capable of completely concealing all technical elements; Up/Down with upward and downward emission. The Recessed version, with a deep section, completely hides technological components and drivers. Each installation type has a series of accessories that enable lines development, angles, and shapes as needed. The system is completed with the power supply section: you can choose between direct supply on the track (with dedicated On/Off or DALI driver) or with a remote driver.

Attacco sospensione
Suspension connection



Angolo verticale interno
Internal vertical angle



Angolo orizzontale sinistro
Left horizontal angle

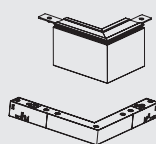

Connessione flessibile
Flex connection



Connessione "L"
"L" connection

Testata aliment. sinistra
Left live end

Terminale
End cap

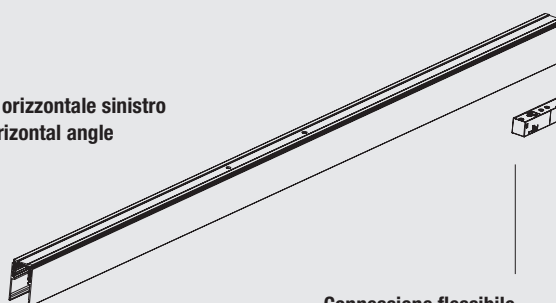
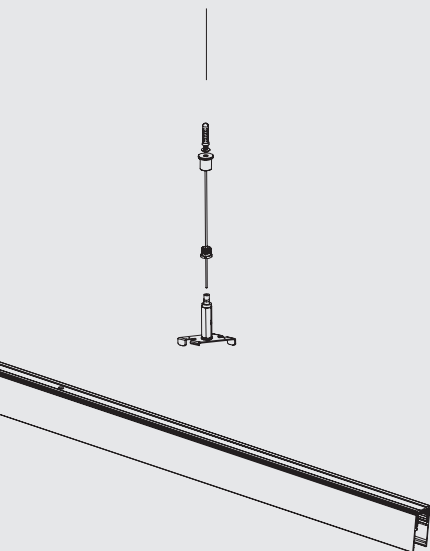

TRACK 48V

Superficie / Sospensione_Small

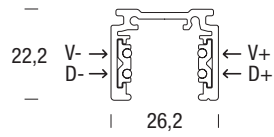

Model	Colour	Code
1000 mm	Bianco	48-AAAW
	Nero	48-AAAB
2000 mm	Bianco	48-AABW
	Nero	48-AABB
3000 mm	Bianco	48-AACW
	Nero	48-AACB

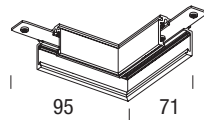

Angolo orizzontale sinistro	Bianco	48-ABAW
Left horizontal angle	Nero	48-ABAB

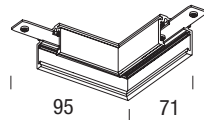

Angolo orizzontale destro	Bianco	48-ABBW
Right horizontal angle	Nero	48-ABBB

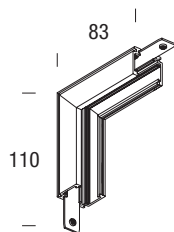

Angolo verticale interno	Bianco	48-ABCW
Internal vertical angle	Nero	48-ABCB

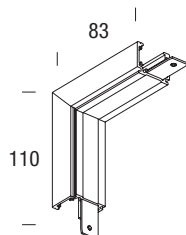

Angolo verticale esterno	Bianco	48-ABDW
External vertical angle	Nero	48-ABDB



Terminale	Bianco	48-ABEW
End cap	Nero	48-ABEB

TRACK 48V

Superficie / Sospensione_Deep

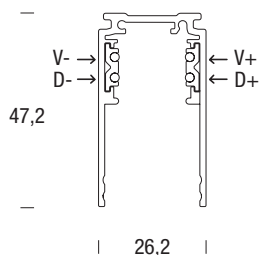
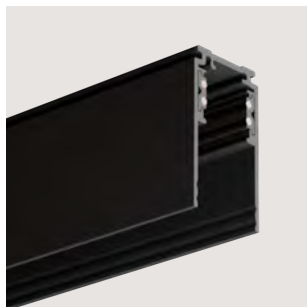

Model	Colour	Code
1000 mm	Bianco	48-DAAW
	Nero	48-DAAB
2000 mm	Bianco	48-DABW
	Nero	48-DABB
3000 mm	Bianco	48-DACW
	Nero	48-DACB

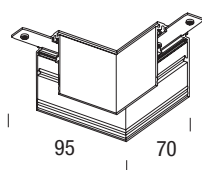

Angolo orizzontale sinistro Left horizontal angle	Bianco	48-DBAW
	Nero	48-DBAB

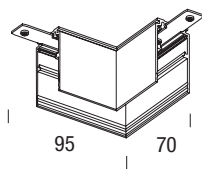

Angolo orizzontale destro Right horizontal angle	Bianco	48-DBBW
	Nero	48-DBBB

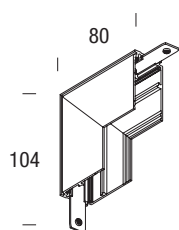

Angolo verticale interno Internal vertical angle	Bianco	48-DBFW
	Nero	48-DBFB

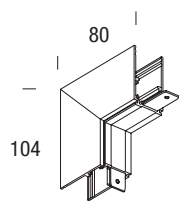

Angolo verticale esterno External vertical angle	Bianco	48-DBGW
	Nero	48-DBGB



Terminale End cap	Bianco	48-DBEW
	Nero	48-DBEB

TRACK 48V

Sospensione_Up/Down

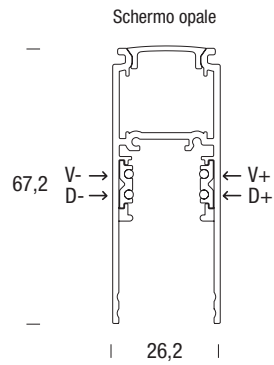

Model	Colour	Code
1000 mm	Bianco	48-CAAW
	Nero	48-CAAB
2000 mm	Bianco	48-CABW
	Nero	48-CABB
3000 mm	Bianco	48-CACW
	Nero	48-CACB

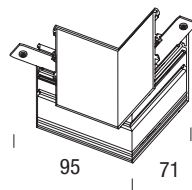

Angolo orizzontale sinistro Left horizontal angle	Bianco	48-CBAW
	Nero	48-CBAB

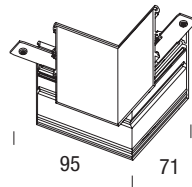

Angolo orizzontale destro Right horizontal angle	Bianco	48-CBBW
	Nero	48-CBBB



Terminale End cap	Bianco	48-CBEW
	Nero	48-CBEB

TRACK 48V

Incasso_Trimless

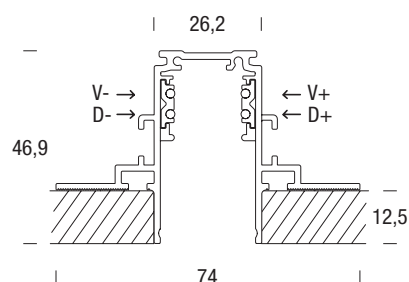
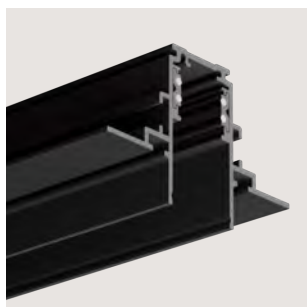

 50 mm

Model	Colour	Code
1000 mm	Nero	48-BAAB
2000 mm	Nero	48-BABB
3000 mm	Nero	48-BACB

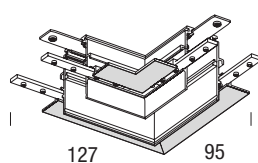

Angolo orizzontale sinistro Left horizontal angle	Nero	48-BBAB
---	------	---------

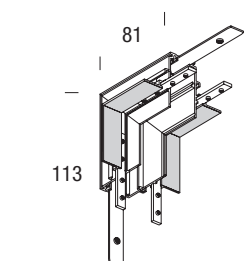

Angolo orizzontale destro Right horizontal angle	Nero	48-BBBB
--	------	---------

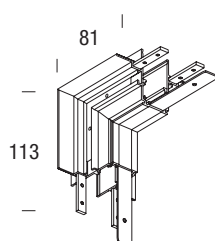

Angolo verticale interno Internal vertical angle	Nero	48-BBFB
--	------	---------

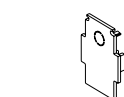

Angolo verticale esterno External vertical angle	Nero	48-BBGB
--	------	---------

Terminale End cap	Nero	48-BBEB
-----------------------------	------	---------

TRACK 48V_ Componenti elettrici

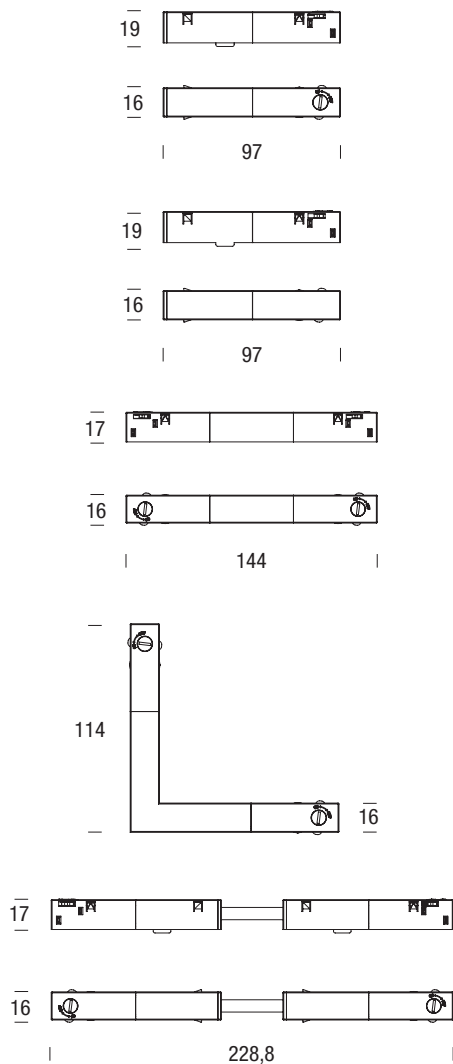

Description

Testata alimentazione sinistra Left live end	Bianco	48-ABHW
	Nero	48-ABHB

Testata alimentazione destra Right live end	Bianco	48-ABIW
	Nero	48-ABIB

Connessione lineare Linear connection	Bianco	48-ABMW
	Nero	48-ABMB

Connessione "L" "L" connection	Bianco	48-ABNW
	Nero	48-ABNB

Connessione flessibile Flex connection	Bianco	48-ABOW
	Nero	48-ABOB

TRACK 48V_ Accessori

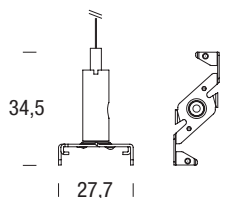
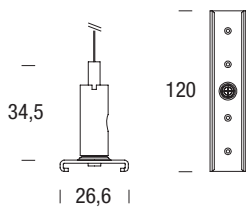

Description

Attacco soffitto Ceiling connection	Bianco	48-ABPW
	Nero	48-ABPB

Kit rinforzo sospensione cavo 3 metri Reinforcement suspension kit 3 meters cable	Bianco	48-ABSW
	Nero	48-ABSB

Attacco sospensione cavo 3 metri Suspension connection 3 meters cable	Bianco	48-ABTW
	Nero	48-ABTB

TRACK 48V_ Rosoni con alimentatore per Soffitto / Parete

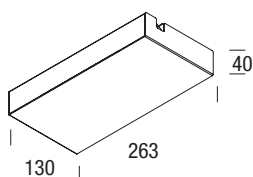
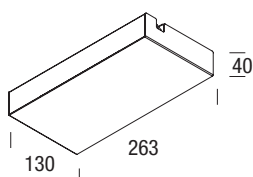
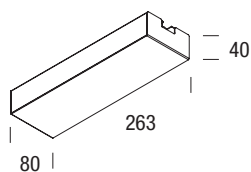

Description		Code to complete *
Rosone ON OFF ON / OFF Canopy	220-240Vac / 60W / On /Off Alimentatore incluso / Driver included	48-ENF ●
	220-240Vac / 120W / On /Off Alimentatore incluso / Driver included	48-FNF ●
⊕	Testata di alimentazione binario non inclusa Track live end not included	
Rosone DALI + Optoisolatore DALI Canopy + electr. insulation	220-240Vac / 60W / DALI Alimentatore e interfaccia inclusi DALI driver + electr. insulation included	48-EDA ●
	220-240Vac / 120W / DALI Alimentatore e interfaccia inclusi DALI driver + electr. insulation included	48-FDA ●
⊕	Testata di alimentazione binario non inclusa Track live end not included	
Rosone SMART - PUSH SMART PUSH Canopy	220-240Vac / 60W / PUSH - SMART Alimentatore e interfaccia inclusi DALI driver + electr. insulation included	48-EPU ●
	220-240Vac / 120W / PUSH - SMART Alimentatore e interfaccia inclusi DALI driver + electr. insulation included	48-FPU ●
⊕	Track live end not included Testata di alimentazione binario non inclusa	

TRACK 48V_ Rosoni senza alimentatore per Soffitto / Parete

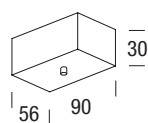
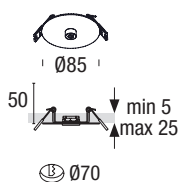

Description		Code to complete *
Rosone ad incasso in controsoffitto Recessed canopy	Alimentatore 48V e Cavo non incluso Driver 48v e cable not included	48-H ●
Rosone a plafone Ceiling canopy	Alimentatore 48V e Cavo non incluso Driver 48v e cable not included	48-G ●

* Select your option

Colour ●

Bianco W

Nero B

TRACK 48V_ DRIVER SU BINARIO

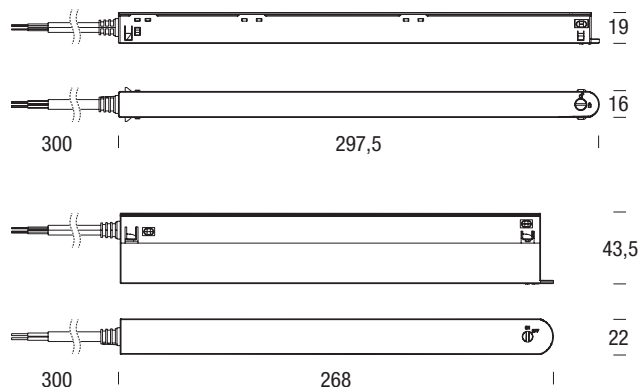

Driver 48Vdc 220-240V - 50/60 Hz 100W; DALI 2 ; Class II; IP20	Bianco	48-ABQW
	Nero	48-ABQB
Driver 48Vdc 220-240V - 50/60 Hz 250W; DALI 2 ; Class II; IP20	Bianco	48-ABRW
	Nero	48-ABRR

TRACK 48V_ DRIVER REMOTO

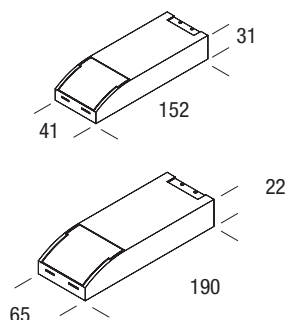

Driver 48Vdc 220-240V - 50/60 Hz 60W; On /Off ; Class II; IP20	DRV4801
Driver 48Vdc 220-240V - 50/60 Hz 120W; On /Off ; Class II; IP20	DRV4802

TRACK 48V_ INTERFACCIA DALI

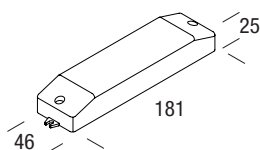

Interfaccia indipendente DALI (DT6/DT8) per binario 48 V. Garantisce l'isolamento tra il master DALI e binario a 48 V. IP20, Class II; Uscita DALI (max. 64 dispositivi) - *Dispositivo obbligatorio con utilizzo CENTRALINA DALI, ripetitore DALI o interfaccia pulsante DALI.	DRV8314
--	----------------

DALI independent interface (DT6/DT8) for 48 V track.
Ensures isolation between the DALI master and the 48 V track. IP20, Class II;
DALI output (max. 64 devices) - *Mandatory device when using DALI CONTROL
UNIT, DALI repeater, or DALI utton interface.

TRACK 48V_ INTERFACCIA PUSH - SMART

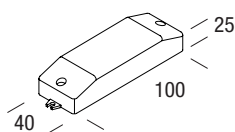

Interfaccia multifunzione WIFI / Bluetooth e pulsante Push Alimentatore BUS DALI integrato fino a 16 dispositivi Gestione tramite app Oikos (WiFi o Bluetooth) Controllabile da remoto tramite Browser Web, APP e assistenti vocali Alexa, Google (solo in modalità WIFI) Cambio modalità tramite app Oikos da broadcast indirizzabile singolarmente. Protezione circuito aperto e picchi di tensione 110- 240Vac - 50/60 Hz; Class II; IP20	DRV8315
---	----------------

Multifunction interface WIFI / Bluetooth and Push button Integrated DALI BUS
power supply for up to 16 devices. Managed via Oikos app (WiFi or Bluetooth)
Remotely controllable via Web Browser, APP, and voice assistants Alexa, Google
(WiFi mode only). Mode change via Oikos app from individually addressable
broadcast Open circuit and surge protection 110-240Vac - 50/60 Hz; Class II;
IP20"

App Link:

Download on the
App Store



ANDROID APP ON
Google play



ESEMPIO DI CONFIGURAZIONE

Vista dall'alto

CONFIGURATION EXAMPLE

Top view

ELECTRICAL COMPONENTS

 **1** Testata alimentazione Sx
Left live end
48-ABHW
48-ABHB

 **2** Testata alimentazione Dx
Right live end
48-ABIW
48-ABIB

 **3** Connessione lineare
Linear connection
48-ABMW
48-ABMB

 **4** Connessione L
L connection
48-ABNW
48-ABNB

MECHANICAL JOINTS

 **A** Angolo orizzontale sinistro
Left horizontal angle

 **B** Angolo orizzontale destro
Right horizontal angle

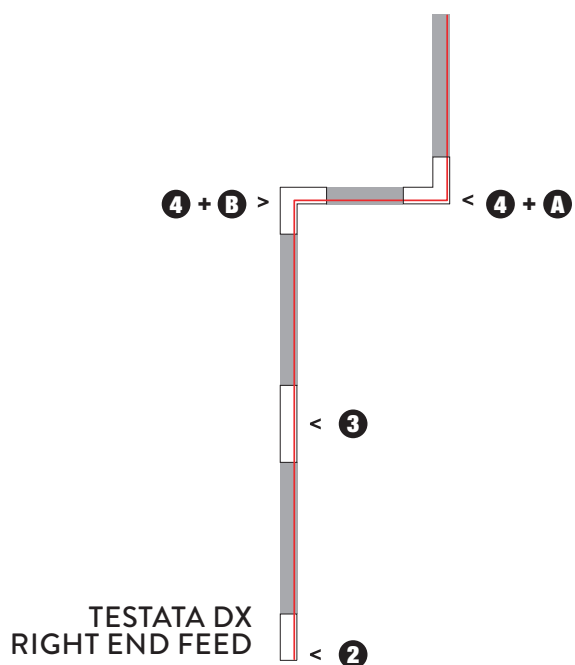
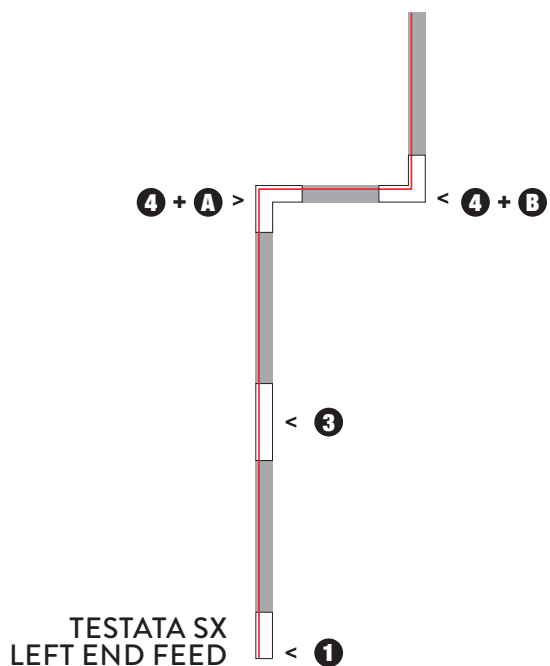

TRACK 48V_ SCHEMI ELETTRICI

On-Off Driver Remoto

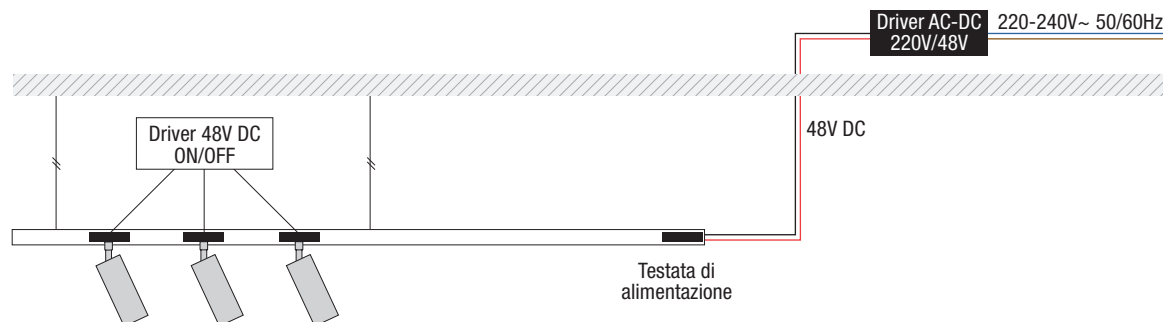

On-Off driver on line

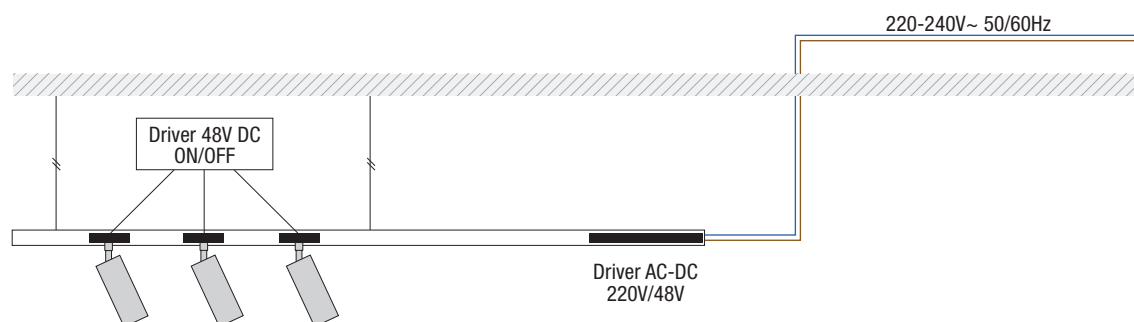

DALI Driver Remoto

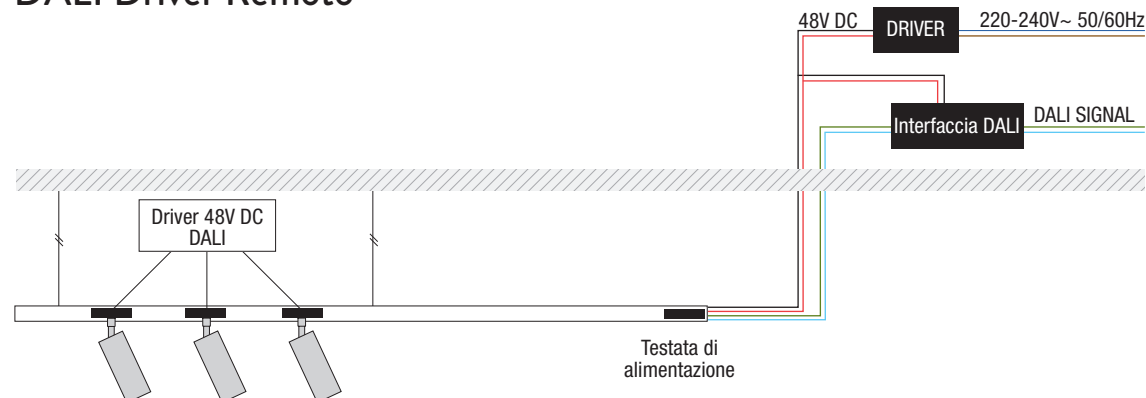

DALI driver on line

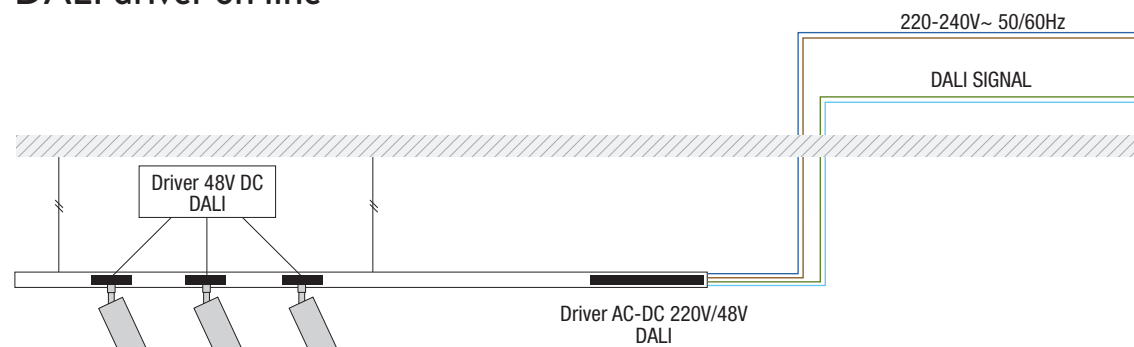

Push Driver Remoto

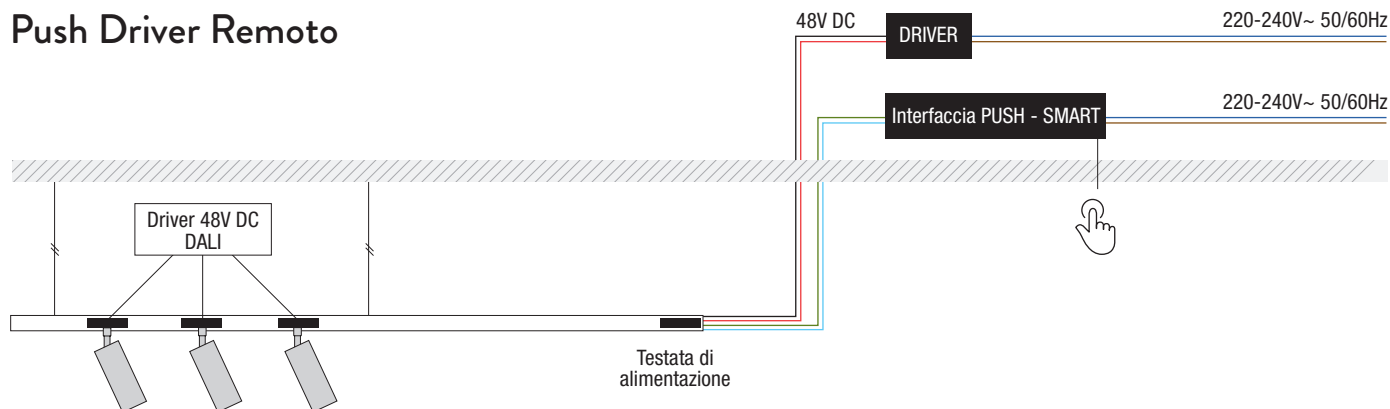

Smart



Tabella caduta di tensione

Driver	A	5 m	10m	20 m	30 m
60 W	B	50 m	50 m	50 m	50 m
120 W	B	50 m	50 m	40 m	25 m

A Distanza alimentazione/testata (2x1,5mm²)
Distance power supply/feed unit (2x1,5mm²)

B Lunghezza binario
Track lenght

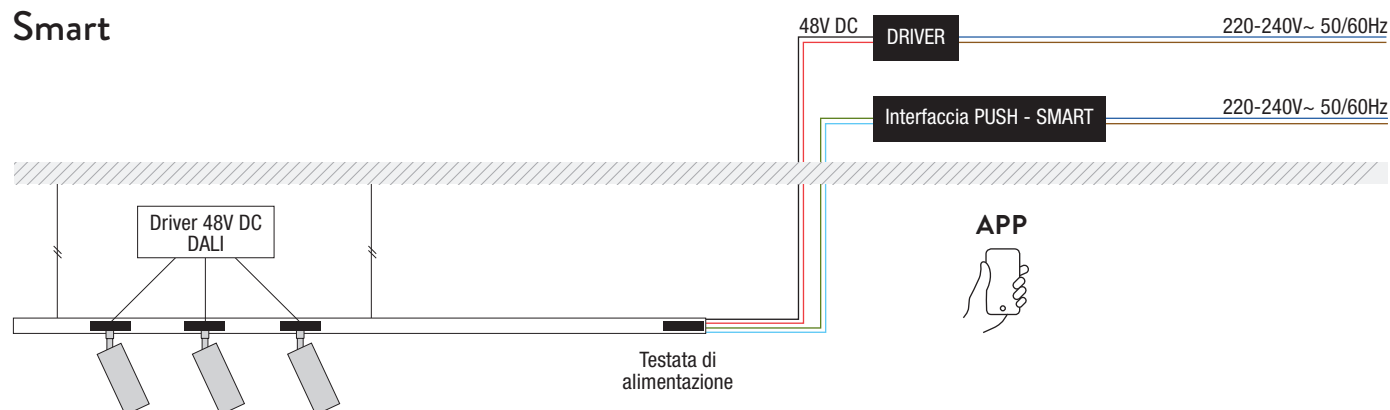
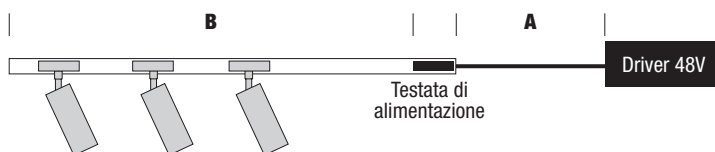

TRACK LIGHTING

COLLECTION



EVOQUE

p.048

5_10_15 W

2700_3000_4000 K

24°_38°_55°

On/Off_Dali

Bianco_Nero_Bronzo spazzolato_
Titanio_Acciaio spazzolato_
Oro spazzolato

EVOQUE ZOOM

p.056

10_15 W

2700_3000_4000 K

15°-36°

On/Off_Dali

Bianco_Nero

MAYA_MICRO

p.072

300_600_900 mm

5_10_15 W

2700_3000_4000 K

30°_55°_120°_Microprismatico

On/Off_Dali

Bianco_Nero

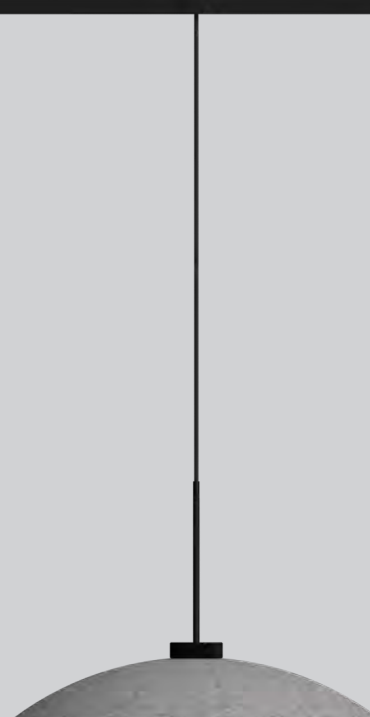

EXTREME

p.062

12_18 W

2700_3000_4000 K

15°_24°_38°_55°_120°

On/Off_Dali

Bianco_Nero_Oro Rosa_
Bronzo spazzolato_Titanio_
Acciaio spazzolato_
Oro spazzolato

ACE_LED

p.068

9,5 W

2700_3000_4000 K

120°

On/Off_Dali

Nero_Oro_Bronzo

ACE_SPHERE

p.068

9,5 W

2700_3000_4000 K

120°

On/Off_Dali

Nero

ACE_ACOUSTIC

p.068

9,5 W

2700_3000_4000 K

120°

On/Off_Dali

Nero

Calotta:
Grigio_Blu_Rosso_Verde



EVOQUE

COLLECTION

IT_La gamma dei proiettori EVOQUE sintetizza le esperienze maturate negli anni su proiettori con dimensioni e potenze superiori. Estetica, attenti equilibri dimensionali, prestazioni elevate ed affidabilità sono caratteri primari della linea EVOQUE 48V. L'apparecchio viene offerto in 3 dimensioni, ognuna ottimizzata per garantire la perfetta dissipazione del calore; garanzia di stabilità e durata nel tempo. I tanti colori disponibili, le ottiche, le schede Led con diverse temperature colore, driver ON OFF e DALI secondo richiesta qualificano la linea EVOQUE 48V l'elemento di punta nella nostra collezione.

EN_The EVOQUE range of projectors highlights the expertise gained over the years with larger and powerful projectors. Aesthetics, careful dimensional balance, high performance, and reliability are primary features of the EVOQUE 48V line. The device is offered in 3 sizes, each optimized to ensure perfect heat dissipation, guaranteeing stability and longevity. The wide range of available colors, optics, LED boards with different color temperatures, and ON/OFF and DALI drivers upon request qualify the EVOQUE 48V line as the flagship of our collection.





CONFIGURATOR





IT_La proposta EVOQUE 48V è ampia e consente il giusto dimensionamento della sorgente luminosa in ogni installazione. Tre i diametri del cilindro in cui viene alloggiato il LED: 35mm, 45mm e 55mm. Potenze disponibili di 5/10/15W. Selezionabili secondo necessità le temperature di colore, le ottiche e la gamma colori. Oltre ai colori verniciati bianco e nero l'offerta prevede altre finiture di altissimo livello realizzate in elettrocromazione: Bronzo spazzolato, Acciaio spazzolato, Oro spazzolato, Titanio; EVOQUE 48V in queste raffinate finiture diventa elemento caratterizzante nell'ambiente in cui è installato. La versione EVOQUE ZOOM semplifica l'utilizzo del proiettore lasciando piena libertà nella gestione del fascio luminoso. La dimmerazione DALI è parte integrante del programma.

EN_The EVOQUE 48V range is extensive and allows for the proper sizing of the light source in every installation. 3 LED housing diameters: 35mm, 45mm, and 55mm. Available power options are 5/10/15W. Color temperatures, optics, and color range can be selected as needed. In addition to the painted white and black colors, the offer includes other high-end finishes made with electro-coloring: Brushed Bronze, Brushed Steel, Brushed Gold, Titanium. EVOQUE 48V in these refined finishes becomes a defining element in the environment where it is installed. The EVOQUE ZOOM version simplifies the use of the projector by allowing full freedom in managing the light beam. DALI dimming is an integral part of the program.

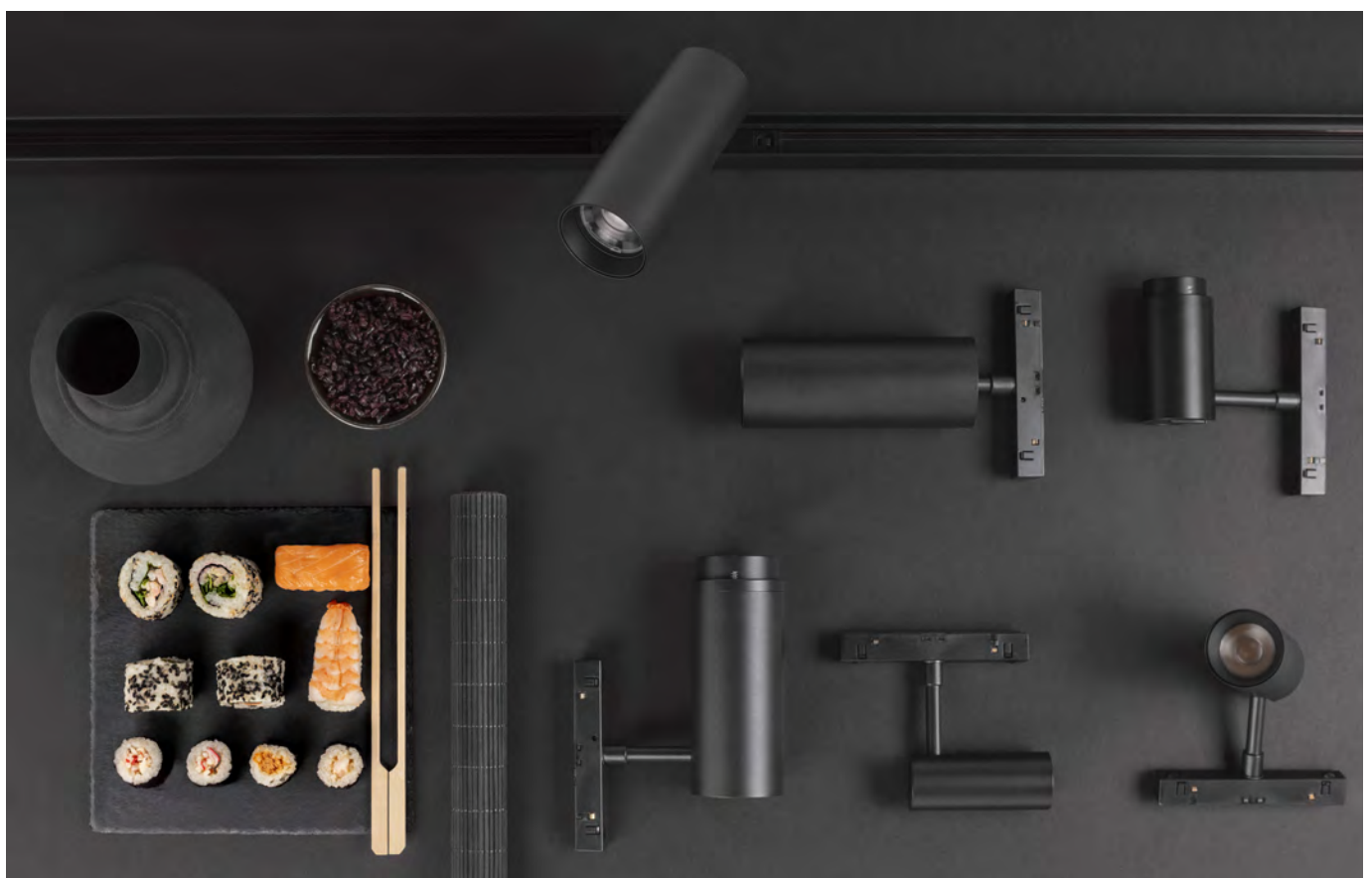



EVOQUE

IT_EVOQUE è un apparecchio poco invasivo e perfettamente equilibrato nei rapporti dimensionali. Si integra perfettamente in ogni installazione. La sua apparente semplicità nasconde caratteristiche tecniche evolute e ricercate. Emissioni nette e senza incertezze grazie alle lenti in polycarbonato, perfetta dissipazione del calore attraverso canali interni di ventilazione, capacità di orientamento di 180° sull'asse verticale. Questa peculiarità colloca EVOQUE 48V tra gli apparecchi più apprezzati per l'illuminazione di show room, mostre d'arte ed impieghi specifici dove la flessibilità diventa elemento primario nella selezione del prodotto.

EN_EVOQUE is a non-invasive device with perfectly balanced proportions. It integrates seamlessly into any installation. Its apparent simplicity conceals advanced and sophisticated technical features. Clear and decisive emissions are achieved through polycarbonate lenses, perfect heat dissipation through internal ventilation channels, and a 180° orientation capability on the vertical axis. This feature places the EVOQUE 48V among the most appreciated devices for showroom lighting, art exhibitions, and specific applications where flexibility becomes a primary factor in product selection.

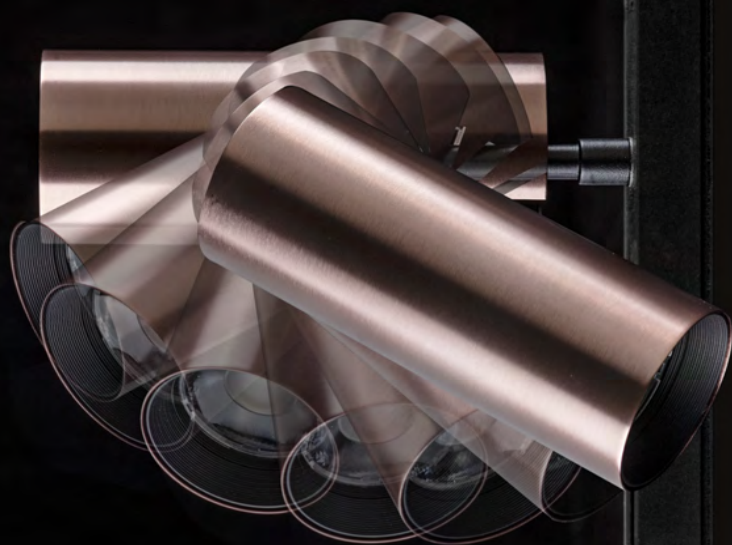



180°

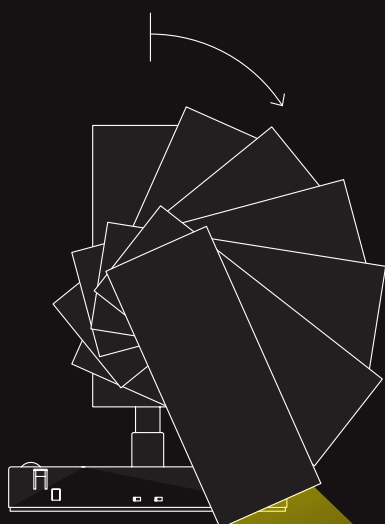

IT Un movimento morbido e senza incertezze permette la rotazione dell'apparecchio per 180° sull'asse verticale. Lo studio e la messa a punto di uno snodo specifico permette questa funzionalità e qualifica EVOQUE 48V tra i prodotti più evoluti della sua categoria.

EN A smooth and decisive movement allows the device to rotate 180° on the vertical axis. The study and development of a specific joint enable this functionality and establish the EVOQUE 48V as one of the most advanced products in its category.

EVOQUE

COLORI

BIANCO/

NERO/

TITANIO/

BRONZO SPAZZOLATO/

ACCIAIO SPAZZOLATO/

ORO SPAZZOLATO/



EVOQUE_ZOOM



EVOQUE ZOOM semplifica la gestione del fascio luminoso. Indispensabile in particolari contesti, permette la gestione del flusso con la semplice rotazione della parte ottica in testa all'apparecchio.

EVOQUE ZOOM simplifies the management of the light beam. Essential in specific contexts, it allows the adjustment of the flow with a simple rotation of the optical part at the head of the device.



CONFIGURATOR



EVOQUE_ZOOM



15° ~ 36°

IT_EVOQUE ZOOM è l'apparecchio ideale per installazioni in cui si richiedano variazioni del flusso luminoso. Gallerie d'arte, museale, show room sono gli ambienti ideali in cui trova impiego la versione ZOOM del proiettore EVOQUE.

EN_EVOQUE ZOOM is the ideal device for installations that require variations in light flow. Art galleries, museums, and showrooms are the perfect environments for the ZOOM version of the EVOQUE projector.

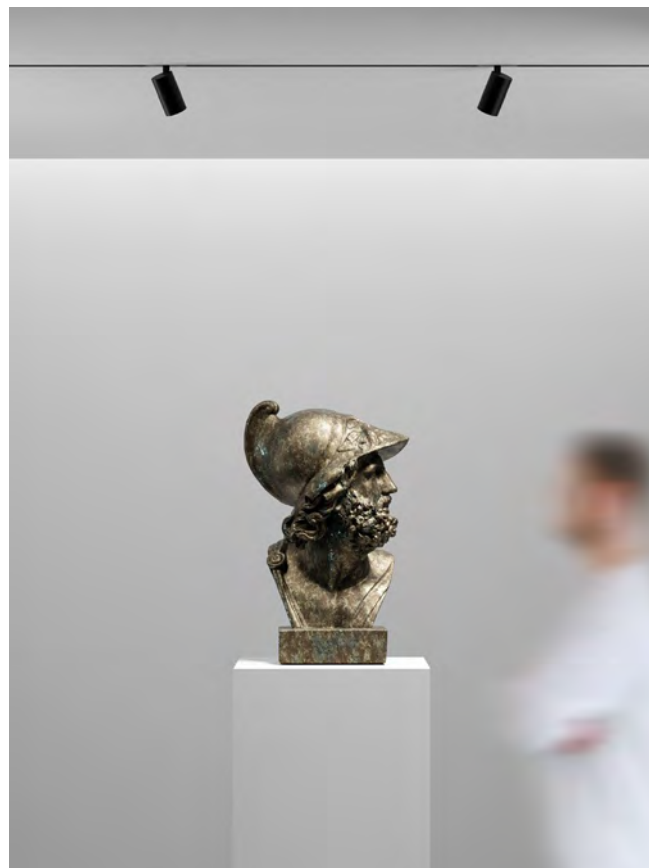

IT_La regolazione del flusso luminoso si ottiene senza l'utilizzo di attrezzi specifici. Basta ruotare la parte anteriore del proiettore con la mano e si ottiene l'effetto desiderato. Il senso di rotazione, orario ed antiorario imposta l'angolo di luce desiderato.

EN_The adjustment of the light flow is achieved without the use of specific tools. Simply rotate the front part of the projector by hand to achieve the desired effect. The direction of rotation, clockwise or counterclockwise, sets the desired light angle

EVOQUE

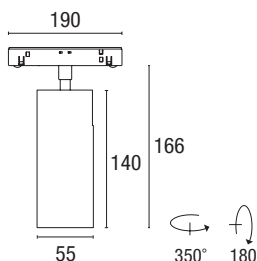
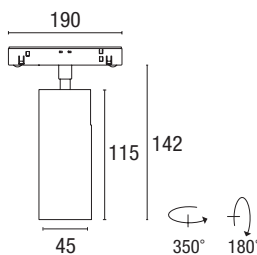
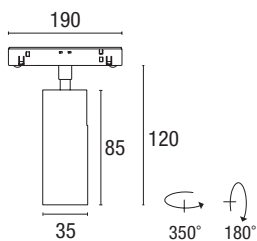

Power	Lumen output	Source	Weight	Code to complete *
5 W	487 lm	CoB LED	0,15 kg	TT-AA ● ■ ▲ ∴ □
◆ 48Vdc IP20	CRI>90 RG1 SCDM<3 - UP to 97,4 lm/W L80/B20 80.000 h. Lumen output values: luminaire luminous flux at 4000 K - optics 24°			
10 W	874 lm	CoB LED	0,23 kg	TT-AB ● ■ ▲ ∴ □
◆ 48Vdc IP20	CRI>90 RG1 SCDM<3 - UP to 97,4 lm/W L80/B20 80.000 h. Lumen output values: luminaire luminous flux at 4000 K - optics 24°			
15 W	1238 lm	CoB LED	0,40 kg	TT-AC ● ■ ▲ ∴ □
◆ 48Vdc IP20	CRI>90 RG1 SCDM<3 - UP to 97,4 lm/W L80/B20 80.000 h. Lumen output values: luminaire luminous flux at 4000 K - optics 24°			

Accessories



Description	Colour	Weight	5 W	10 W	15 W
Honeycomb Nero		0,02 kg	RTL28017	RTL28018	RTL28019

*** Select your option**

Colour adapter	●	CCT	■	Optic	▲	Control	∴	Colour	□
Bianco	W	2700 K	1	24°	2	On/Off	NV	Bianco	W
Nero	B	3000 K	2	38°	3	DALI	DV	Nero	B
		4000 K	3	55°	4			Bronzo spazzolato	Z
								Titanio	T
								Acciaio spazzolato	A
								Oro spazzolato	Y

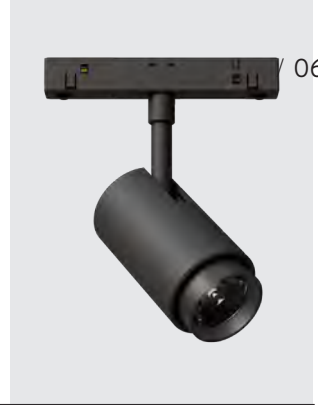

EVOQUE_ZOOM

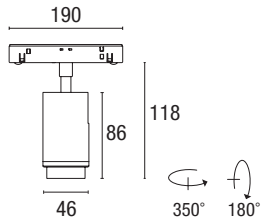

Power	Lumen output	Source	Optical	Weight	Code to complete *
10 W	614 lm	CoB LED	Zoom 15°-36°	0,30 kg	TZ-AB ● ■ ☛ □

◆ 48Vdc | IP20

CRI>90 | RG1 | SCDM<3 - UP to 61 lm/W | L80/B20 80.000 h.
Lumen output values: luminaire luminous flux at 4000 K

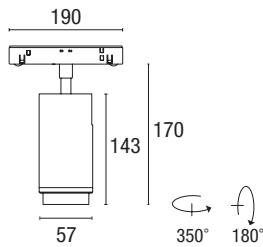

15 W	1069 lm	CoB LED	Zoom 15°-36°	0,36 kg	TZ-AC ● ■ ☛ □
------	---------	---------	-----------------	---------	----------------------

◆ 48Vdc | IP20

CRI>90 | RG1 | SCDM<3 - UP to 61 lm/W | L80/B20 80.000 h.
Lumen output values: luminaire luminous flux at 4000 K

*** Select your option**

Colour adapter		CCT		Control		Colour	
Bianco	W	2700 K	1	On/Off	NV	Bianco	W
Nero	B	3000 K	2	DALI	DV	Nero	B
		4000 K	3				



EXTREME

COLLECTION

Il progetto Extreme estende la sua gamma d'impiego. Con la versione TRACK 48V consolida il valore di una collezione trasversale ed integrata. L'apparecchio, totalmente orientabile sull'asse verticale ed orizzontale, massimizza il suo impiego e le prestazioni grazie alle diverse ottiche, le possibilità di gestione delle elettroniche e le temperature colore del Led, a scelta tra 2700/3000/4000K. Le finiture dell'anello in alluminio tornito, elemento distintivo della collezione, sono ottenute con processi tecnologici all'avanguardia e qualificano marcatamente gli ambienti in cui vengono installati.

EN The Extreme project expands its range of applications. With the TRACK 48V version, it consolidates the value of a cross-cutting and integrated collection. The device, fully adjustable on both the vertical and horizontal axes, maximizes its use and performance thanks to the various optics, management options for the electronics, and color temperatures of the LED, available in 2700/3000/4000K. The finishes of the turned aluminum ring, a distinctive element of the collection, are achieved through cutting-edge technological processes and significantly enhance the environments where they are installed.



CONFIGURATOR



EXTREME

COLLECTION

15°

24°

38°

55°

120°



BIANCO/
NERO/
TITANIO/
ORO ROSA/
BRONZO SPAZZOLATO/
ACCIAIO SPAZZOLATO/
ORO SPAZZOLATO/



EXTREME_Track

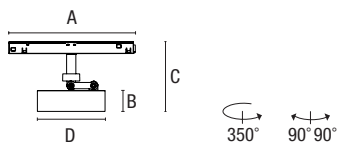

Power	Lumen output	Product dimension				Weight	code to complete*
		A	B	C	D		
12W	1447 lm	190 mm	32 mm	107 mm	103 mm	0,43 kg	TF-AA + ● □ ⋮ ▼
18W	1852 lm	190 mm	32 mm	107 mm	103 mm	0,43 kg	TF-AB + ● □ ⋮ ▼

48Vdc | IP20

CoB LED | CRI>90 | RG1 | SDCM<3
 UP to 104 lm/W | L80/B20 80.000 h.
 Lumen output values: luminaire luminous flux at 4000 K - optics 38°

*** Select your option**

Colour Adapter +	CCT ●	Optic □	Control ⋮	Colour Ring ▼
Bianco W	2700 K 1	15° 1	On/Off NV	Bianco W
Nero B	3000 K 2	24° 2	DALI DV	Nero B
	4000 K 3	38° 3		Oro rosa S
		55° 4		Bronzo spazzolato Z
				Titanio T
				Acciaio spazzolato A
				Oro spazzolato Y

EXTREME_Track

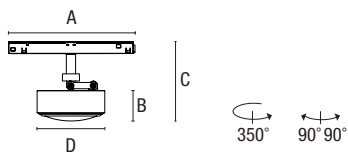

Power	Lumen output	Product dimension				Weight	code to complete *
		A	B	C	D		
12W	1128 lm	190 mm	47 mm	122 mm	103 mm	0,55 kg	TF-AA
18W	1852 lm	190 mm	47 mm	122 mm	103 mm	0,55 kg	TF-AB

48Vdc | IP20

CoB LED | CRI>90 | RG1 | SDCM<3
 UP to 88 lm/W | L70/B10 60.000 h.
 Lumen output values: luminaire luminous flux at 4000 K

* Select your option

Colour Adapter	CCT	Optic	Control	Colour Ring
Bianco W	2700 K 1	120° 5	On/Off NV	Bianco W
Nero B	3000 K 2		DALI DV	Nero B
	4000 K 3			Oro rosa S
				Bronzo spazzolato Z
				Titanio T
				Acciaio spazzolato A
				Oro spazzolato Y

ACE

COLLECTION

IT_Nelle installazioni TRACK 48V trovano spazio le sospensioni ACE ed ACE_Acoustic. Due elementi, che aumentano le possibilità d'installazione. Il modulo LED, da 9,5W è la soluzione ideale per illuminazione d'ambiente, desk ed applicazioni integrate con spot 48V.

EN_In the TRACK 48V installations, ACE and ACE_Acoustic suspensions are included. These two elements expand the installation possibilities. The 9,5W LED module is the ideal solution for ambient lighting, desk lighting, and integrated applications with 48V spots.



ACE_Led

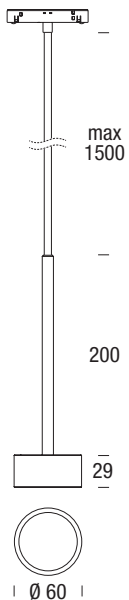
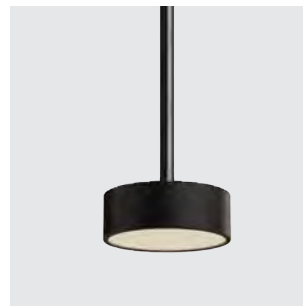

Power	Lumen output	Code to complete *
9,5 W	700 lm	CA-SB ■ ▲ ❖

◆ 48Vdc | IP20

CRI>80 | RG0 | SCDM<3 - UP to 73 lm/W | L80/B20 60.000 h.
Lumen output values: luminaire luminous flux at 4000 K

*** Select your option**

Colour		CCT		Control	
Nero	B	2700 K	1	On/Off	NV
Oro	S	3000 K	2	DALI	DV
Bronzo	Z	4000 K	3		

ACE_Glass

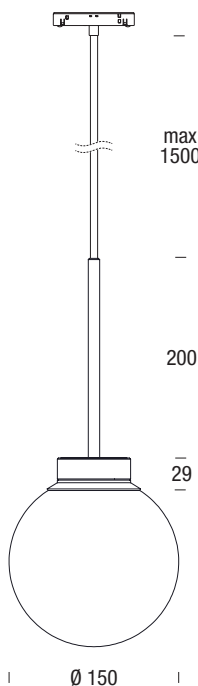

Power	Lumen output	Code to complete *
9,5 W	560 lm	CC-S ■ ▲ ❖

◆ 48Vdc | IP20

CRI>80 | RG0 | SCDM<3 - UP to 59 lm/W | L80/B20 60.000 h.
Lumen output values: luminaire luminous flux at 4000 K

*** Select your option**

Colour		CCT		Control	
Nero	B	2700 K	1	On/Off	NV
		3000 K	2	DALI	DV
		4000 K	3		

TRACK LIGHTING

ACE / ACOUSTIC_Led

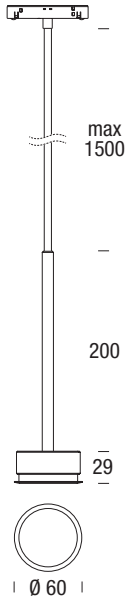

Power	Lumen output	Code to complete *
9,5 W	700 lm	CB-SB ■ ▲ ❖

◆ 48Vdc | IP20

CRI>80 | RG0 | SCDM<3 - UP to 73 lm/W | L80/B20 60.000 h.
Lumen output values: luminaire luminous flux at 4000 K

* Select your option

Colour		CCT		Control	
Nero	B	2700 K	1	On/Off	NV
		3000 K	2	DALI	DV
		4000 K	3		

CALOTTA

Description		Code to complete *
Calotta	Ø 450_H.80	BSS01A ❖
	Ø 600_H.154	BSS01B ❖



* Select your option

Colour	
Grigio / Grey	G
Blu / Blue	B
Rosso / Red	R
Verde / Green	Y

MAYA_MICRO

TRACK



IT_Maya_Micro TRACK 48V è l'elemento luminoso lineare che integra la collezione TRACK_48V. Questa soluzione, minimale e con livelli di efficienza luminosa elevatissimi, offre diverse opportunità d'impiego. Viene proposta in 3 lunghezze: 300, 600 e 900 mm. Sull'apparecchio si possono montare ottiche con angoli di emissione puntuale (UGR), schermi prismatici oppure satinati utili per illuminazione diffusa. Possibilità di dimmerazione DALI e schede LED nelle temperature colore 2700/3000/4000K.

EN_Maya_Micro TRACK 48V is the linear lighting element that integrates the TRACK_48V collection. This minimal solution, with extremely high levels of luminous efficiency, offers various application opportunities. It is available in three lengths: 300, 600, and 900mm. The device can accommodate optics with focused emission angles (UGR), as well as prismatic or frosted screens useful for diffuse lighting. It offers DALI dimming capabilities and LED boards with color temperatures of 2700/3000/4000K.



CONFIGURATOR



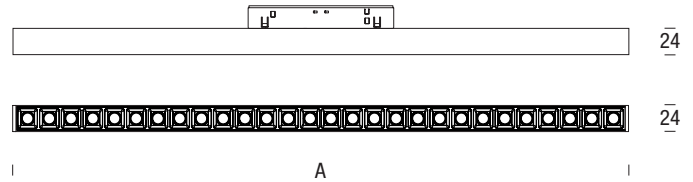

MAYA_MICRO

Downlight	Model	Power	Lumen output	Dimension	Code to complete *
	300	5 W	695 lm	287 mm	ZM-TD ● ■ △ ☼ ☐
	600	10 W	1390 lm	566 mm	ZM-TE ● ■ △ ☼ ☐
	900	15 W	2100 lm	846 mm	ZM-TF ● ■ △ ☼ ☐

◆ 48Vdc | IP20

UP to 139 lm/W | UP to UGR≥16 | L80/B20 80.000 h. | CRI>90 | UP to RG0 | SDCM<3
Lumen output values: luminaire luminous flux at 4000 K - optics 30°

* Select your option

Colour adapter ●	CCT ■	Optic △	Control ☼	Structure colour ☐
Bianco W	2700 K 1	30° Bianco A	On/Off NV	Bianco WW
Nero B	3000 K 2	30° Nero B	DALI DV	Nero BB
	4000 K 3	55° Bianco C		
		55° Nero D		
		120° E		
		Micro M		



TWENTY

COLLECTION





CONFIGURATOR



20MM - “MARCATA IDENTITÀ” UN CONDENSATO DI TECNOLOGIA & RAFFINATA QUALITÀ COSTRUTTIVA.

20MM - “STRONG IDENTITY” A CONCENTRATE OF TECHNOLOGY & REFINED CONSTRUCTION QUALITY



20 mm

IT_20 millimetri è il diametro del sistema luminoso Twenty. Una proposta ricca di soluzioni, tecnologie, finiture e modelli utilizzabili nell'illuminazione residenziale contemporanea. Linee sottili, cura del dettaglio, estetica raffinata, ampia scelta di colori e modelli. In gamma troviamo lampade da terra dimmerabili, sospensioni orizzontali e verticali, apparecchi da parete e soffitto. Twenty, in ogni declinazione, esprime carattere e stile. Un gioiello assoluto capace di qualificare l'ambiente in cui viene installato.

EN_20 mm is the diameter of the light system Twenty. A wide proposal in solutions, technologies, finishes and models easy to use in contemporary residential lighting. Fine lines, attention to detail, refined aesthetics, wide choice of colors and patterns. The range includes dimmable floor lamps, horizontal and vertical suspensions, wall and ceiling luminaires. Twenty, in every version, expresses character and style. An absolute jewel capable of qualifying the environment in which it is installed.





IT_L'apparente semplicità della costruzione "TWENTY" nasconde un carattere raffinato facilmente utilizzabile nelle diverse installazioni. La qualità dei materiali e le scelte costruttive specifiche dell'apparecchio classificano TWENTY tra i nostri prodotti di punta. A completare il quadro contribuisce l'alto livello delle finiture che, oltre alle verniciature bianco e nero, si apprezzano con le versioni spazzolate champagne, tabacco e grigio lunare. Twenty garantisce ottime rese luminose ed prodotto ideale nell'arredamento contemporaneo.

EN_The apparent simplicity of the "TWENTY" construction conceals a refined character that is easily usable in various installations. The quality of the materials and the specific construction choices classify TWENTY among our flagship products. Contributing to the overall picture is the high level of finishes, which, in addition to white and black paint, are enhanced by brushed champagne, tobacco, and lunar grey. TWENTY ensures excellent luminous performance and is an ideal product for contemporary furnishings.



Parete_Riflessa

DETTAGLI CHE FANNO LA DIFFERENZA

DETAILS
MAKE THE
DIFFERENCE





Tesata Verticale_Riflessa

**NERO/
BIANCO/
GRIGIO LUNARE/
CHAMPAGNE/
TABACCO/**

IT_Twenty viene proposto in 5 finiture. Una gamma colori attenta alle richieste del mercato: verniciato bianco e nero, elettrocolorazione graffiata nelle versioni champagne, tabacco e grigio lunare. L'alto livello qualitativo, con le attenzioni costruttive poste ai dettagli, offrono un quadro d'insieme particolarmente interessante.

EN_Twenty is offered in 5 finishes. A color range attentive to market demands: painted in white and black, and electro-colored with brushed versions in champagne, tobacco, and lunar grey finishes. The high quality level, along with the construction focus on details, provides a particularly interesting overall picture.





IT_Tra le diverse proposte, il modello a sospensione occupa una posizione centrale nel nostro catalogo. TWENTY sospensione si può installare in posizione orizzontale o verticale. Sono 3 le misure disponibili per impieghi orizzontali: lunghezza 1100/1700/2200mm. l'apparecchio monta Led di ultima generazione e garantisce un flusso luminoso morbido e funzionale alle comuni installazioni in cui si prevede il posizionamento dell'apparecchio su piani di lavoro. Il modello verticale, disponibile nelle lunghezze 600/900/1100mm consente l'impiego anche in spazi limitati per creare effetti luce accattivanti.

EN_Among the various proposals, the suspended model holds a central position in our catalog. The TWENTY suspended light can be installed in a horizontal or vertical position. There are 3 sizes available for horizontal applications: lengths of 1100/1700/2200mm. The device features the latest generation LEDs and ensures a soft luminous flux suitable for common installations where the device is expected to be placed on work surfaces. The vertical model, available in lengths of 600/900/1100mm, allows for use in limited spaces to create captivating lighting effects.

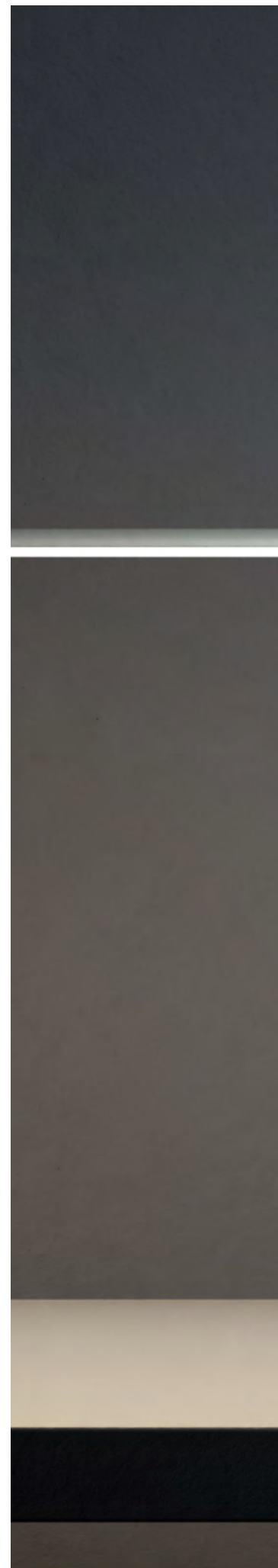
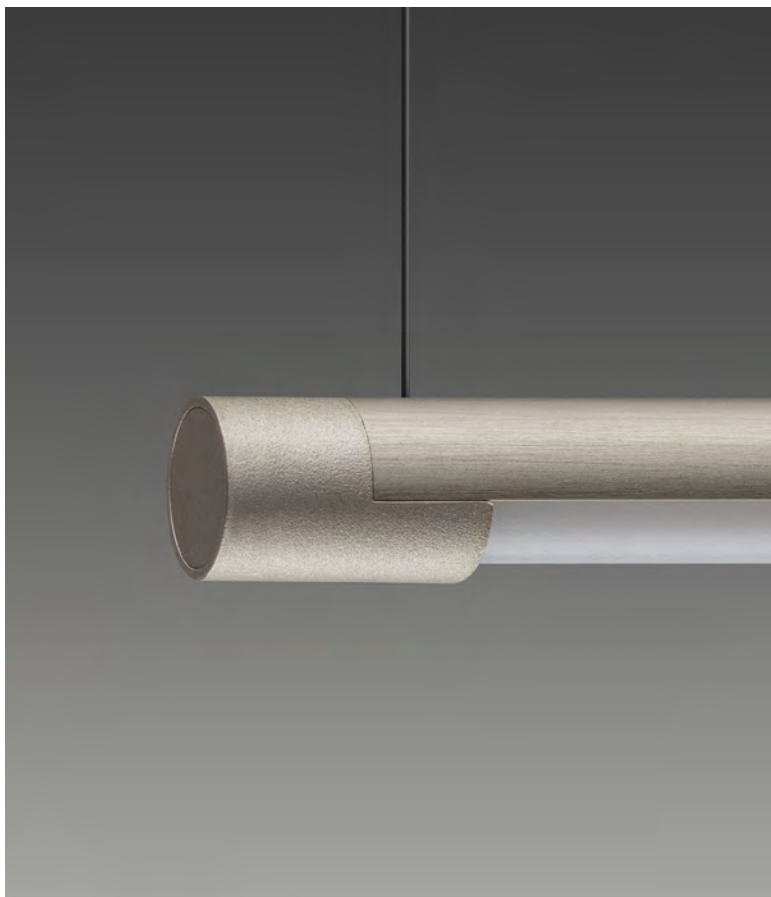

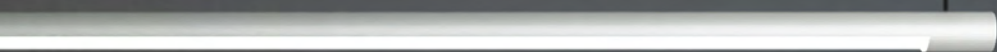

Sospensione_Diretta



Da terra



Sospensione

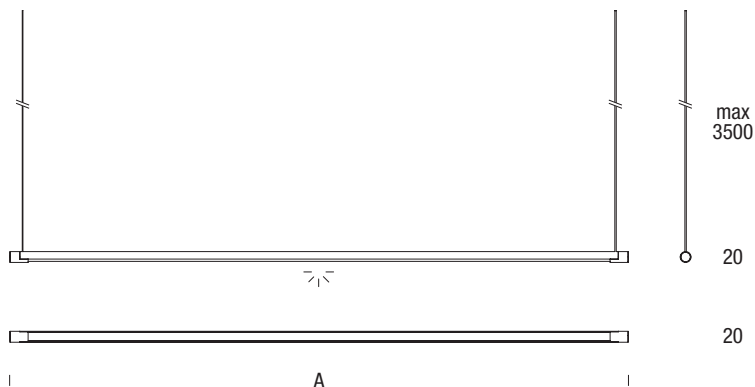

Model	Power	Lumen output	Dimension A	Code to complete *
1100	20 W	1620 lm	1184 mm	VS-AA ■ ▲
1700	34 W	2754 lm	1743 mm	VS-AB ■ ▲
2200	40 W	3240 lm	2302 mm	VS-AC ■ ▲

◆ 24Vdc | IP40

UP to 81 lm/W | opal diffuser | L70/B50 > 36.000 h. | CRI>90 | RG0
Lumen output values: luminaire luminous flux at 4000 K

* Select your option

CCT	Colour
2700 K 1	Bianco WW
3000 K 2	Nero BB
4000 K 3	Grigio lunare GG
	Champagne EE
	Tabacco OO

ACCESSORI

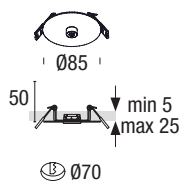
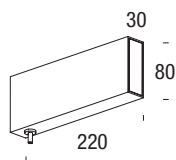

Description	Code to complete *
Rosone 220-240Vac, alimentatore incluso	VSS02 ● ■
Incasso 220-240Vac, alimentatore incluso	VSS04 ● ■

* Select your option

Colour	Control
Bianco W	On/Off NF
Nero B	DALI DA
	Push PU

TWENTY

Sospensione Verticale

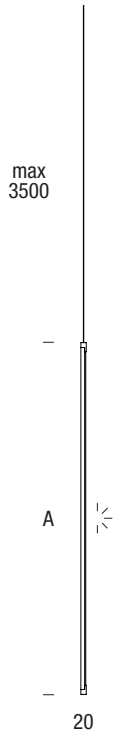

Model	Power	Lumen output	Dimension A	Code to complete *
600	10 W	883 lm	665 mm	VR-BF ■ ▲
900	16 W	1325 lm	887 mm	VR-BG ■ ▲
1100	20 W	1620 lm	1136 mm	VR-BA ■ ▲

◆ 24Vdc | IP40

UP to 81 lm/W | opal diffuser | L70/B50 > 36.000 h. | CRI>90 | RGO
Lumen output values: luminaire luminous flux at 4000 K

* Select your option

CCT		Colour	
2700 K	1	Bianco	WW
3000 K	2	Nero	BB
4000 K	3	Grigio lunare	GG
		Champagne	EE
		Tabacco	OO

ACCESSORI

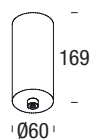

Description	Code to complete *
Rosone 220-240Vac, alimentatore incluso	VSS03 ■ NF

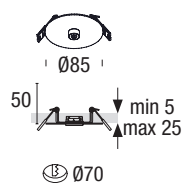

Incasso 220-240Vac, alimentatore incluso	VSS04 ■ ■
--	-----------

* Select your option

Colour		Control	
Bianco	W	On/Off	NF
Nero	B	DALI	DA
		Push	PU

Tesata Verticale

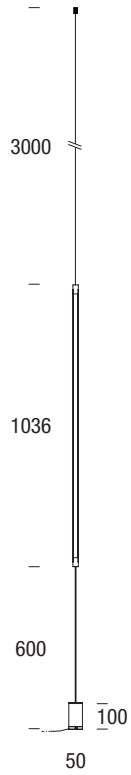

Dimmer a pedale con memoria
Foot dimmer with memory

Model	Power	Lumen output	Code to complete *
1100	20 W	1620 lm	VV-BA ■ ▲

□ 220÷240Vac | IP40

UP to 81 lm/W | opal diffuser | L70/B50 > 36.000 h. | CRI>90 | RGO
Lumen output values: luminaire luminous flux at 4000 K

* Select your option

CCT	■	Colour	▲
2700 K	1	Bianco	WW
3000 K	2	Nero	BB
4000 K	3	Grigio lunare	GG
		Champagne	EE
		Tabacco	OO

TWENTY

Parete

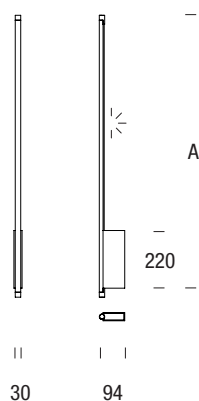

Model	Power	Lumen output	Dimension A	Code to complete *
600	10 W	883 lm	665 mm	VW-BF ■ ■ ■ △
1100	20 W	1620 lm	1036 mm	VW-BA ■ ■ ■ △

□ 220÷240Vac | IP40

UP to 81 lm/W | opal diffuser | L70/B50 > 36.000 h. | CRI>90 | RGO
Lumen output values: luminaire luminous flux at 4000 K

* Select your option

CCT	■	Control	■ ■	Colour	△
2700 K	1	On/Off	NF	Bianco	WW
3000 K	2	DALI	DA	Nero	BB
4000 K	3			Grigio lunare	GG
				Champagne	EE
				Tabacco	00

Plafone

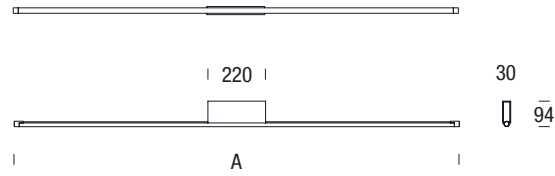

Diretta

Model	Power	Lumen output	Dimension A	Code to complete *
1100	20 W	1620 lm	1136 mm	VC-AA ■ :: △
1700	34 W	2754 lm	1636 mm	VC-AB ■ :: △

Riflessa

1100	16 W	1325 lm	1136 mm	VC-BA ■ :: △
1700	27 W	2187 lm	1636 mm	VC-BB ■ :: △

220÷240Vac | IP40

UP to 81 lm/W | opal diffuser | L70/B50 > 36.000 h. | CRI>90 | RG0
Lumen output values: luminaire luminous flux at 4000 K

* Select your option

CCT	■	Control	::	Colour	△
2700 K	1	On/Off	NF	Bianco	WW
3000 K	2	DALI	DA	Nero	BB
4000 K	3			Grigio lunare	GG
				Champagne	EE
				Tabacco	00

TWENTY

Da Terra

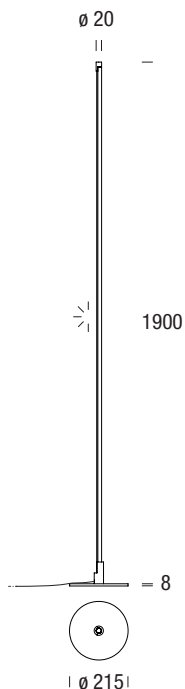

Dimmer a pedale con memoria
Foot dimmer with memory

Model	Power	Lumen output	Dimension A	Code to complete *
1900	38 W	3078 lm	1900 mm	VE-OD ■ ▲
2400	44 W	3564 lm	2400 mm	VE-OE ■ ▲

□ 220÷240Vac | IP40

UP to 81 lm/W | opal diffuser | L70/B50 > 36.000 h. | CRI>90 | RGO
Lumen output values: luminaire luminous flux at 4000 K

* Select your option

CCT	Colour
2700 K 1	Bianco WW
3000 K 2	Nero BB
4000 K 3	Grigio lunare GG
	Champagne EE
	Tabacco OO

BASE



∅ 215

Description	Code to complete *
Base	VE-P ■■

Base colour ■■

Bianco	WW
Nero	BB
Grigio lunare	GG
Champagne	EE
Tabacco	OO

MAYA_MICRO

COLLECTION

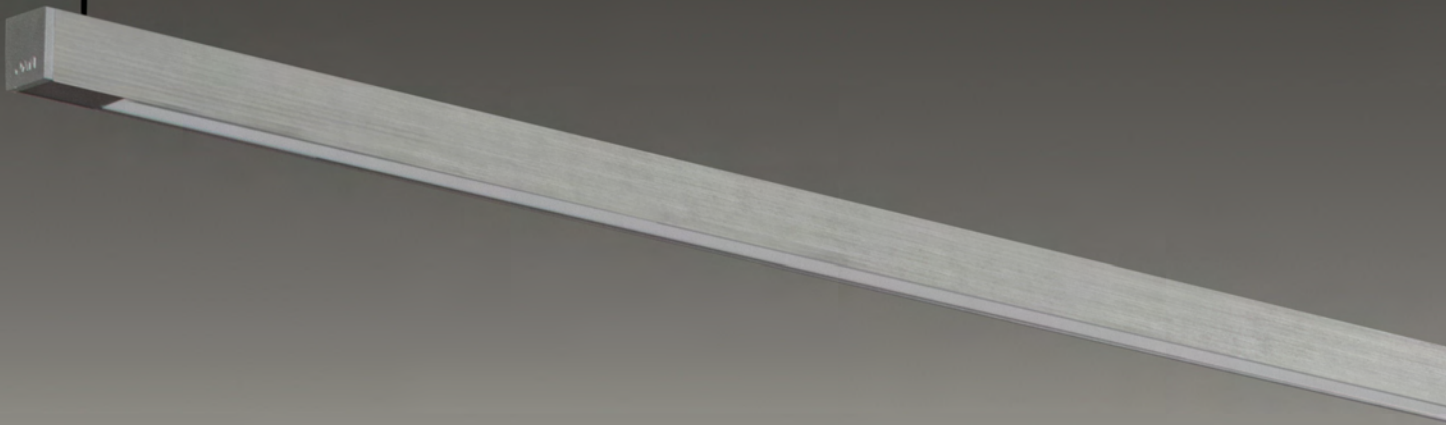

MISURE CONTENUTE, PRESTAZIONI DI VERTICE

COMPACT DIMENSIONS, TOP PERFORMANCE.

IT_Un profilo in alluminio con sezioni decisamente contenute è la generatrice con cui è stato concepito Maya_Micro. La versione a sospensione rappresenta l'elemento centrale che esalta estetica, tecnologia, prestazioni di questo progetto frutto delle esperienze maturate nel tempo. Maya Micro utilizza schede Led di massima efficienza e si presta per innumerevoli installazioni. Ampiezza di gamma, dettagli costruttivi, estetica, tecnologia, emergono chiaramente e collocano Maya Micro tra i best seller della nostra proposta.

EN_An aluminum profile with decidedly compact sections is the generator with which Maya_Micro was conceived. The suspended version represents the central element that enhances the aesthetics, technology, and performance of this project, a result of experiences gained over time. Maya Micro uses highly efficient LED boards and is suitable for countless installations. The wide range of options, construction details, aesthetics, and technology clearly emerge, placing Maya Micro among the best sellers in our offering.

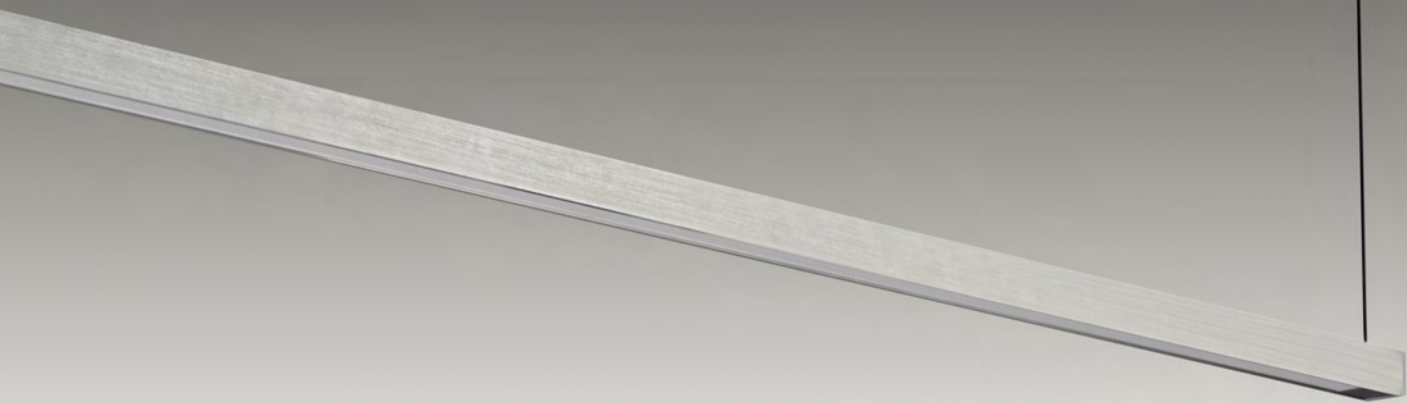

CONFIGURATOR



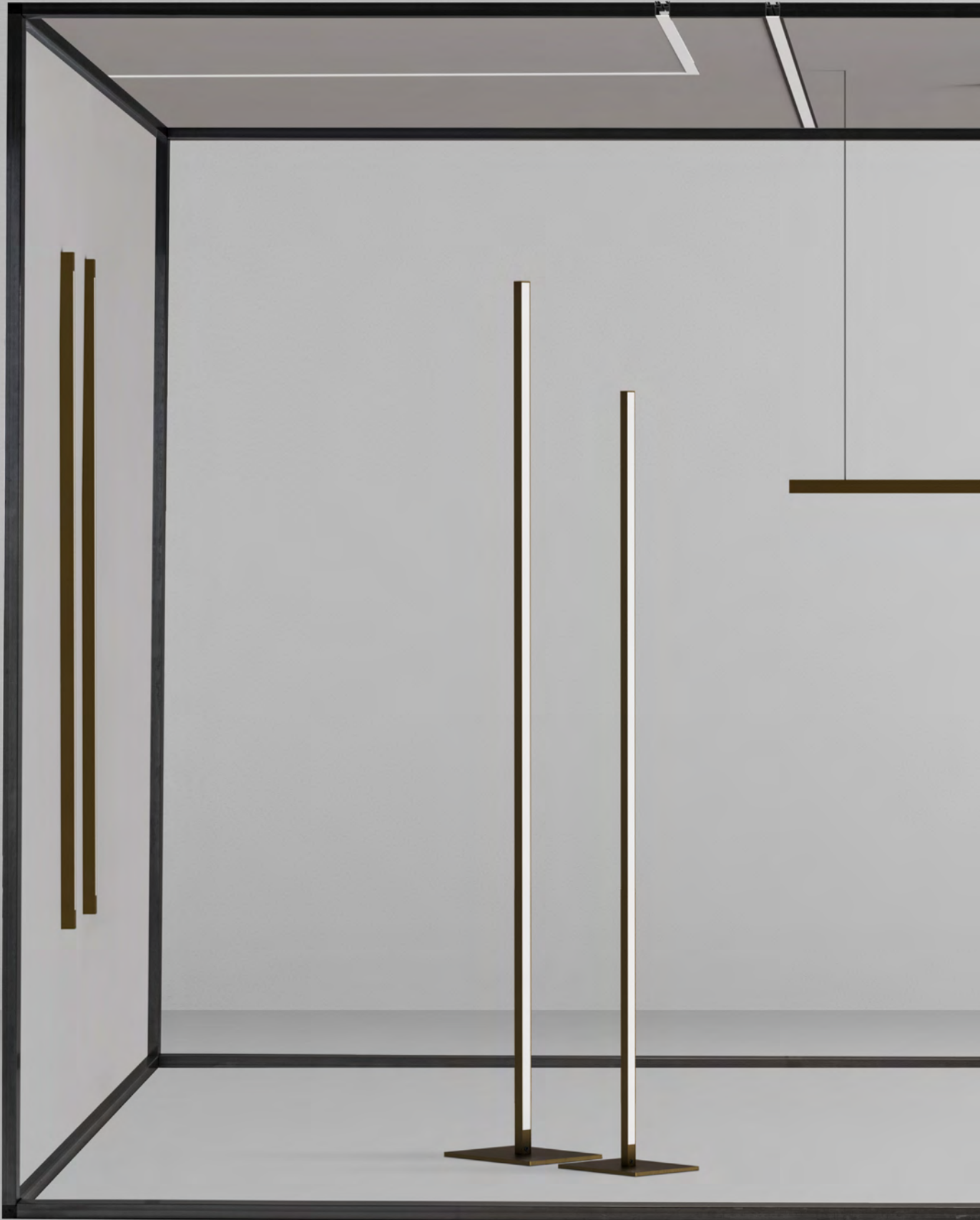

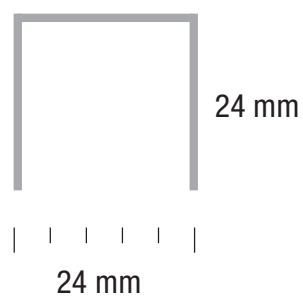
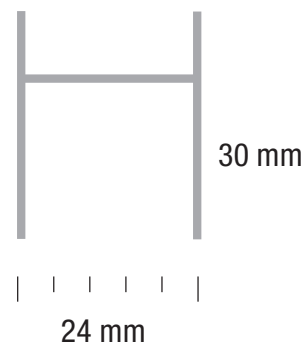

Luce diretta**Luce diretta
e diretta/indiretta**

IT_ La nuova generazione del profilo Maya_Micro minimizza le dimensioni e raggiunge livelli di efficienza elevatissimi. Presentiamo una gamma completa per applicazioni, sviluppi, colori e tecnologie. Affidabilità, qualità costruttiva e cura del dettaglio, sono i criteri che animano la nostra proposta.

EN_ The new generation of the Maya_Micro profile minimizes dimensions and achieves very high efficiency levels. We present a complete range for applications, developments, colors and technologies. Reliability, construction quality and attention to detail are the criteria that animate our proposal.



IT_ La gestione dei flussi luminosi trova completa soluzione nel programma Micro_Maya. Indipendentemente dal tipo d'installazione, dalla misura e dal colore dell'apparecchio si può scegliere tra uno schermo satinato, microprismatico oppure lenti secondarie che garantiscono altissima efficienza e perfetto controllo dell'abbagliamento. Le ridotte dimensioni del profilo, i flussi luminosi importanti, le infinite combinazioni di misure, colori, gestioni; offrono infinite possibilità d'impiego nella progettazione dello spazio contemporaneo.

EN_ The management of light flows is fully resolved in the Micro_Maya program. Regardless of the type of installation, the size, and product color, can choose between a satin screen, micro-prismatic, or secondary lenses that ensure high efficiency and perfect glare control. The reduced dimensions of the profile, significant luminous flows, and infinite combinations of sizes, colors, and controls offer endless possibilities for use in the design of contemporary spaces.

30°/55°/120° MICROPRISMATIC





**BIANCO/
NERO/
TABACCO/
CHAMPAGNE/
GRIGIO LUNARE/**

IT_Anche le finiture sono allineate alle principali richieste del mercato. Non solo verniciature base in bianco e nero ma anche soluzioni più qualificate ed attente alla percezione di qualità elevata: su questa base nascono i graffiati champagne, tabacco e grigio lunare. L'alto livello qualitativo che caratterizza MAYA_MICRO con le attenzioni costruttive poste ai dettagli, conferma l'alto livello tecnico racchiuso nei nostri apparecchi.

EN_The finishes are also aligned with the main market demands. Not only basic paints in white and black but also more refined solutions that emphasize a high perception of quality: on this base we propose brushed champagne, tobacco, and lunar gray finishes. The high-quality level that characterizes MAYA_MICRO, along with the construction focus on details, confirms the excellent technical standard enclosed in our devices.

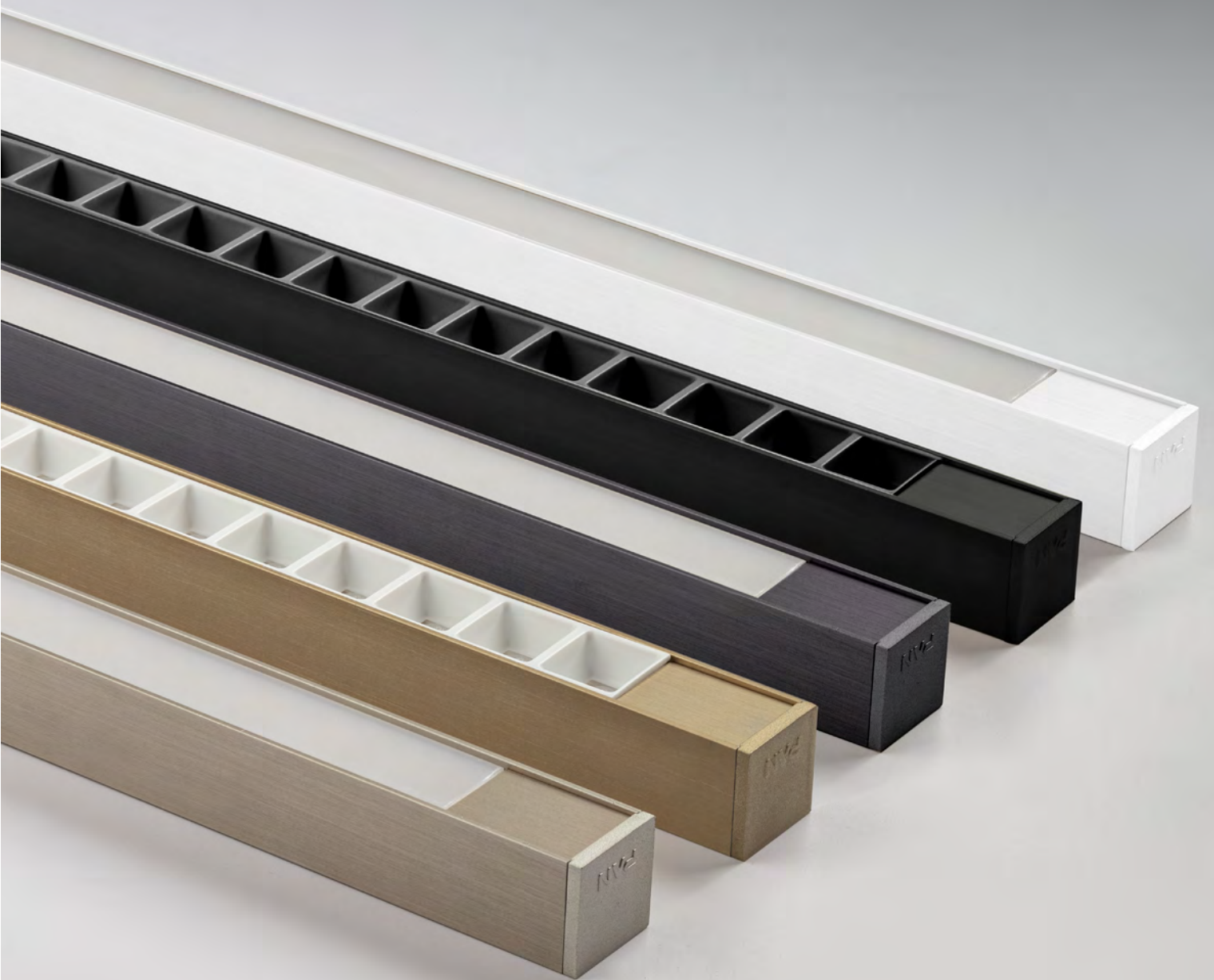

MAYA_MICRO

COLLECTION

IT_La riduzione dimensionale che proponiamo con il progetto MAYA_MICRO segna un passaggio centrale nella crescita della nostra azienda. Diverse le tipologie d'installazione previste: lampade da terra, sospensioni, apparecchi da parete e soffitto, gruppi da incasso con diverse misure rendono la proposta ideale per la progettazione degli spazi interni. In ogni sezione troviamo diverse varianti per misure, potenze, colori, ottiche e gestioni. Per ottimizzare le scelte nella gamma decisamente vasta è disponibile un configuratore on line che visualizza graficamente il prodotto e consente l'accesso al data base tecnico.

EN_The dimensional reduction that we propose with the MAYA_MICRO project marks a central transition in the growth of our company. There are several types of installations planned: floor lamps, suspensions, wall and ceiling fixtures, and recessed units in various sizes, making the offering ideal for designing interior spaces. In each section, we find different variants for sizes, powers, colors, optics, and controls. To optimize choices an online configurator is available. Visually displays the product and provides access to the technical database.

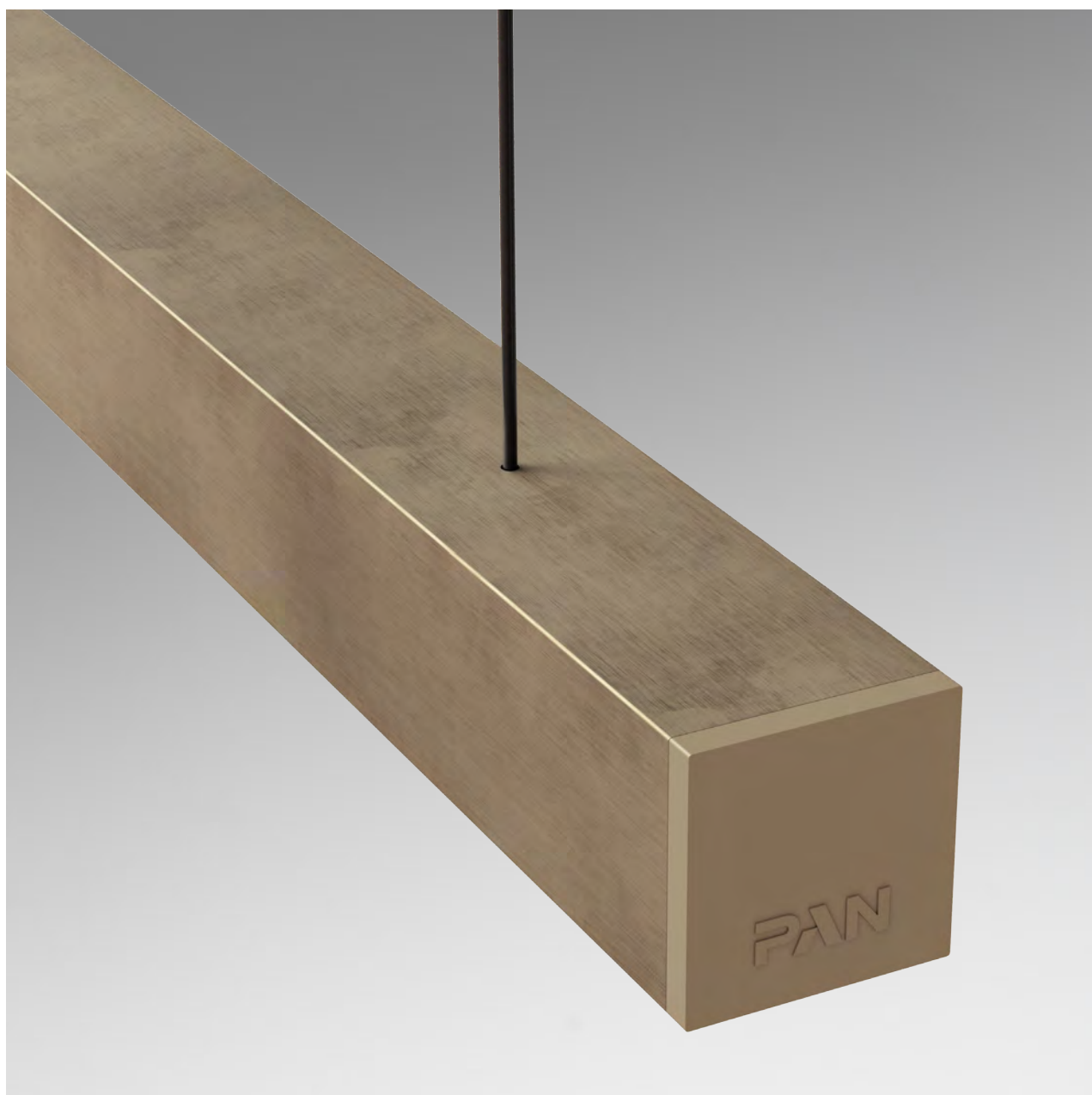

**ESTETICA, TECNOLOGIA E
FUNZIONALITÀ AI MASSIMI
LIVELLI. UNA SINTESI
FORMALE PERFETTA
CONSEGUENZA DI SCELTE
ALL'AVANGUARDIA.**

**AESTHETICS, TECHNOLOGY,
AND FUNCTIONALITY AT THE
HIGHEST LEVELS. A PERFECT
FORMAL SYNTHESIS RESULTING
FROM CUTTING-EDGE CHOICES.**



ROSONE



INCASSO





**UN POSTO DI PRIMO PIANO PER LA LAMPADA
CON FINITURA "ANTIQUE GOLD". RIENTRA TRA
LE FINITURE SPECIALI REALIZZABILI PER
PARTICOLARI PROGETTI.**

**A PROMINENT PLACE FOR THE LAMP WITH AN "ANTIQUE GOLD"
FINISH. IT FALLS AMONG THE SPECIAL FINISHES THAT CAN BE
MADE FOR SPECIFIC PROJECTS**

MAYA_MICRO

COLLECTION



MAYA_MICRO

Sospensione_24

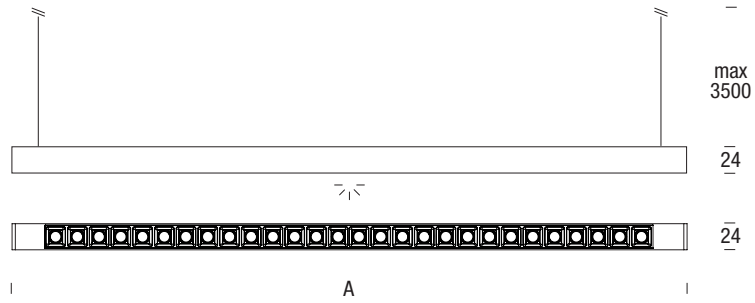

Diretta

Model	Power	Lumen output		Dimension A	Code to complete *
		downlight	uplight		
1100	20 W	2780 lm	-	1184 mm	ZM-SAG ■ △ □
1700	30 W	4170 lm	-	1743 mm	ZM-SAI ■ △ □
2200	40 W	5560 lm	-	2302 mm	ZM-SAL ■ △ □

◆ Moduli SELV (V < 60 V) | IP40

UP to 139 lm/W | UP to UGR≥16 | L80/B20 80.000 h. | CRI>90 | UP to RG0 | SDCM<3
Lumen output values: luminaire luminous flux at 4000 K - optics 30°

* Select your option

CCT		Optic		Structure colour	
2700 K	1	30° Bianco	A	Bianco	WWW
3000 K	2	30° Nero	B	Nero	BBB
4000 K	3	55° Bianco	C	Grigio lunare	GGG
		55° Nero	D	Tabacco	000
		120°	E	Champagne	EEE
		Micro	M		

ALIMENTAZIONE

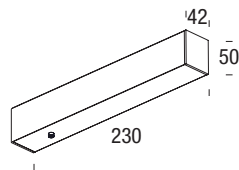

Description	Code to complete *
Rosone 220-240Vac, alimentatore incluso	ZSS021 ● ●
Rosone 220-240Vac, alimentatore incluso Solo: 2200 / Only: 2200	ZSS022 ● ●

* Select your option

Colour		Control	
Bianco	W	On/Off	NF
Nero	B	DALI	DA
Grigio lunare	G	Push	PU
Tabacco	O		
Champagne	E		

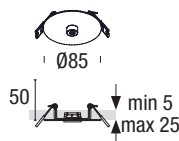

Incasso 220-240Vac, alimentatore incluso	ZSS041 ○ ◇
Incasso 220-240Vac, alimentatore incluso Solo: 2200 / Only: 2200	ZSS042 ○ ◇

* Select your option

Colour		Control	
Bianco	W	On/Off	NF
Nero	B	DALI	DA
		Push	PU

Sospensione_30

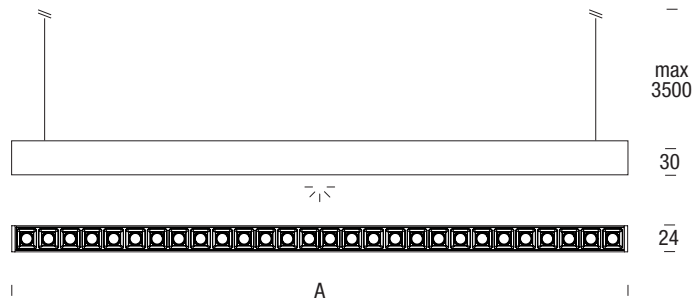

Diretta

Model	Power	Lumen output		Dimension	Code to complete *
		downlight	uplight		
1100	20 W	2780 lm	-	1125 mm	ZM-RAG ■ ▲ □
1700	30 W	4170 lm	-	1684 mm	ZM-RAI ■ ▲ □
2200	40 W	5560 lm	-	2243 mm	ZM-RAL ■ ▲ □

◆ Moduli SELV (V < 60 V) | IP40

UP to 139 lm/W | UP to UGR≥16 | L80/B20 80.000 h. | CRI>90 | UP to RG0 | SDCM<3
Lumen output values: luminaire luminous flux at 4000 K - optics 30°

* Select your option

CCT	■	Optic	▲	Structure colour	□
2700 K	1	30° Bianco	A	Bianco	WW
3000 K	2	30° Nero	B	Nero	BB
4000 K	3	55° Bianco	C	Grigio lunare	GG
		55° Nero	D	Tabacco	OO
		120°	E	Champagne	EE
		Micro	M		

ALIMENTAZIONE

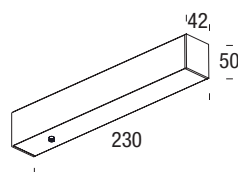

Description	Code to complete *
Rosone 220-240Vac, alimentatore incluso	ZSS021 ● ●
Rosone 220-240Vac, alimentatore incluso Solo: 2200 / Only: 2200	ZSS022 ● ●

* Select your option

Colour	●	Control	●●
Bianco	W	On/Off	NF
Nero	B	DALI	DA
Grigio lunare	G	Push	PU
Tabacco	O		
Champagne	E		

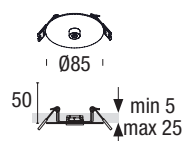

Description	Code to complete *
Incasso 220-240Vac, alimentatore incluso	ZSS041 ○ ◇
Incasso 220-240Vac, alimentatore incluso Solo: 2200 / Only: 2200	ZSS042 ○ ◇

* Select your option

Colour	○	Control	◇
Bianco	W	On/Off	NF
Nero	B	DALI	DA
		Push	PU

MAYA_MICRO

Sospensione_30

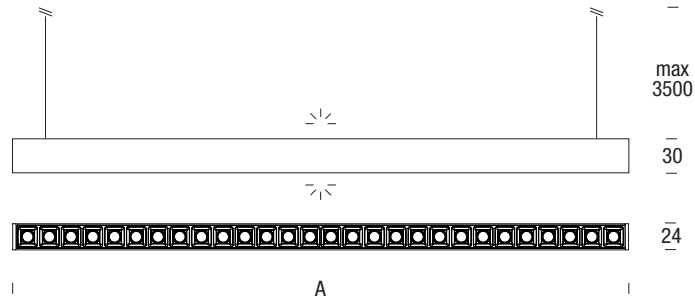

Diretta/Indiretta

Model	Power	Lumen output		Dimension	Code to complete *
		downlight	uplight		
1100	20+10 W	2780 lm	850 lm	1125 mm	ZM-RBG ■ ▲ □
1700	30+10 W	4170 lm	850 lm	1684 mm	ZM-RBI ■ ▲ □
2200	40+20 W	5560 lm	1700 lm	2243 mm	ZM-RBL ■ ▲ □

◆ Moduli SELV (V < 60 V) | IP40

UP to 139 lm/W | UP to UGR≥16 | L80/B20 80.000 h. | CRI>90 | UP to RG0 | SDCM<3
Lumen output values: luminaire luminous flux at 4000 K - optics 30°

* Select your option

CCT	Optic	Structure colour
2700 K 1	30° Bianco A	Bianco WW
3000 K 2	30° Nero B	Nero BB
4000 K 3	55° Bianco C	Grigio lunare GG
	55° Nero D	Tabacco OO
	120° E	Champagne EE
	Micro M	

ALIMENTAZIONE

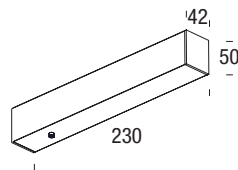

Description	Code to complete *
Rosone 220-240Vac, alimentatore incluso (2X_Solo: 2200 / Only: 2200)	ZSS021 ● ☺

* Select your option

Colour	Control
Bianco W	On/Off NF
Nero B	DALI DA
Grigio lunare G	Push PU
Tabacco O	
Champagne E	

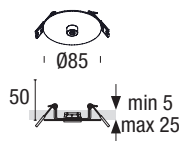

Description	Code to complete *
Incasso 220-240Vac, alimentatore incluso (2X_Solo: 2200 / Only: 2200)	ZSS041 ○ ◇

* Select your option

Colour	Control
Bianco W	On/Off NF
Nero B	DALI DA
	Push PU

**DETTAGLI
COSTRUTTIVI,
ESTETICA E
TECNOLOGIA**

**CONSTRUCTION
DETAILS, AESTHETICS,
AND TECHNOLOGY**

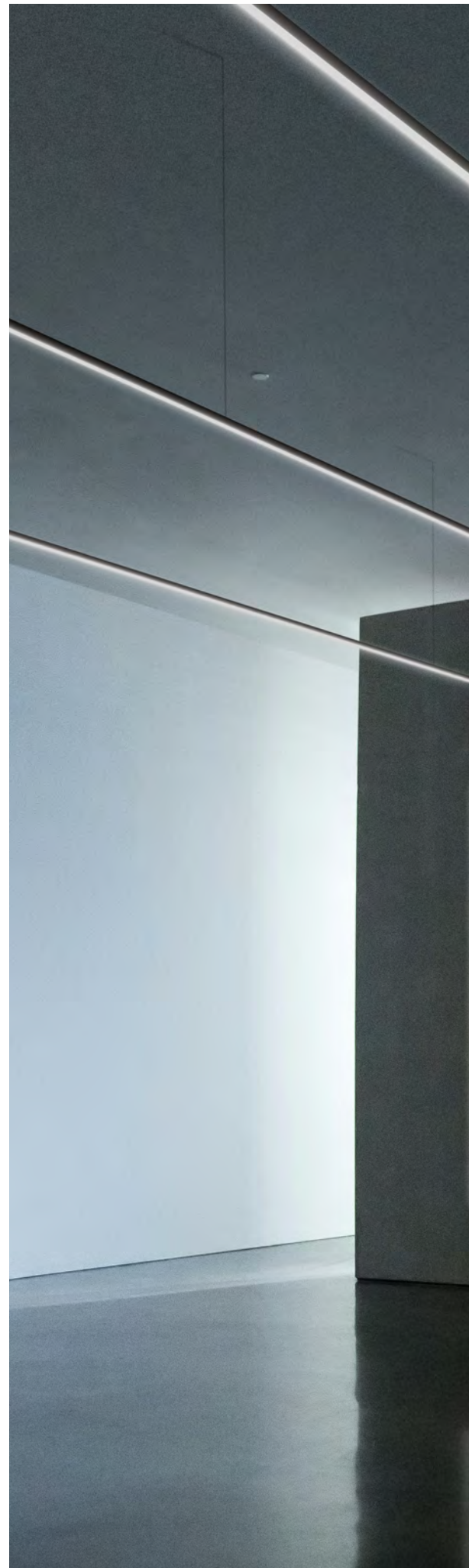



Soffitto/Parete 24

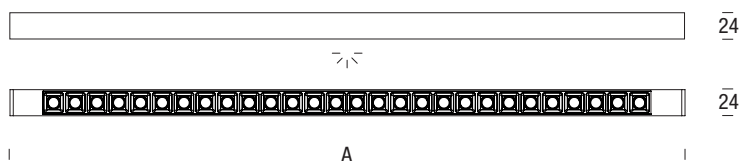

Diretta

Model	Power	Lumen output	Dimension	Code to complete*
300	5 W	695 lm	346 mm	ZM-CAD ■ ▲ □
600	10 W	1390 lm	625 mm	ZM-CAE ■ ▲ □
900	15 W	2085 lm	901 mm	ZM-CAF ■ ▲ □
1100	20 W	2780 lm	1184 mm	ZM-CAG ■ ▲ □
1400	25 W	3475 lm	1463 mm	ZM-CAH ■ ▲ □

◆ Moduli SELV (V < 60 V) | IP40

UP to 139 lm/W | UP to UGR≥16 | L80/B20 80.000 h. | CRI>90 | UP to RG0 | SDCM<3
Lumen output values: luminaire luminous flux at 4000 K - optics 30°

* Select your option

CCT	■	Optic	△	Structure colour	□
2700 K	1	30° Bianco	A	Bianco	WWW
3000 K	2	30° Nero	B	Nero	BBB
4000 K	3	55° Bianco	C	Grigio lunare	GGG
		55° Nero	D	Tabacco	000
		120°	E	Champagne	EEE
		Micro	M		

ALIMENTAZIONE REMOTA

Description	Code to complete
Alimentatori	On/Off
220-240Vac,	DALI/PUSH
	SLE0164
	SLE0166

MAYA_MICRO

Da Terra

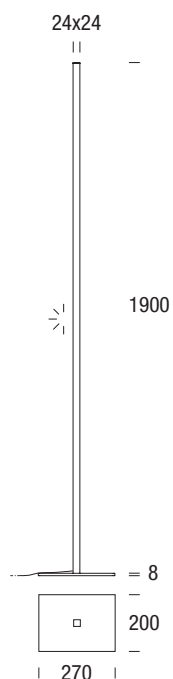

Dimmer a pedale con memoria
Foot dimmer with memory

Model	Power	Lumen output	Code to complete *
1900	34 W	2486 lm	ZM-EON ■ ▲ □ ●
2400	48 W	3552 lm	ZM-E00 ■ ▲ □ ●

□ 220÷240Vac | IP40

UP to 74 lm/W | opal diffuser | L70/B50 > 36.000 h. | CRI>90 | RG0
Lumen output values: luminaire luminous flux at 4000 K

* Select your option

CCT	Optic	Control	Structure colour
2700 K 1	120° E	Dimmer DM	Bianco WW
3000 K 2		Voice Control Tuya + RF TU	Nero BB
4000 K 3			Grigio lunare GG
Tunable ** 4			Tabacco OO
			Champagne EE

** Solo/Only: Voice Control Tuya + RF

BASE



Description	Code to complete *
Base	ZM-EP ■■

Base colour ■■

Bianco	WW
Nero	BB
Grigio lunare	GG
Tabacco	OO
Champagne	EE

MAYA_MICRO

COLLECTION

INCASSO_

INCASSO_NANO



60 mm



120 mm

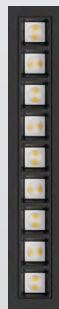

180 mm



300 mm



600 mm



1100 mm

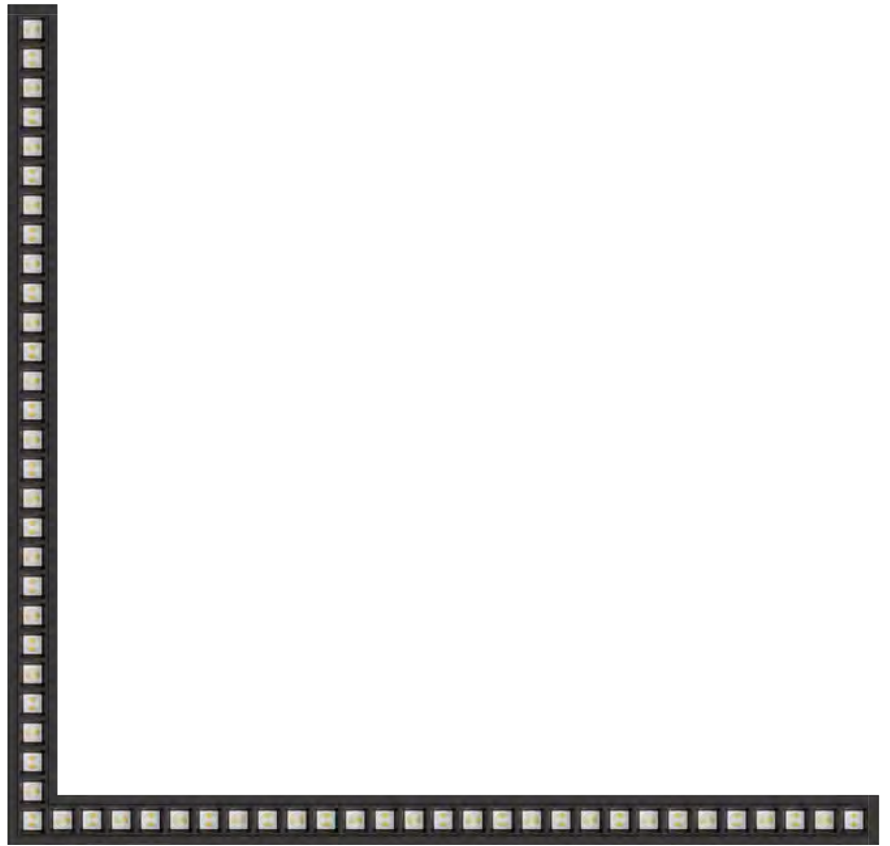

600X600 mm

MAYA_MICRO

COLLECTION

INCASSO_ NANO

60 mm

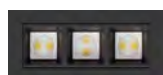

120 mm

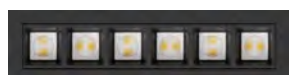

180 mm

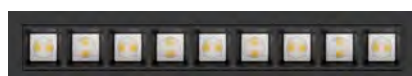

300 mm

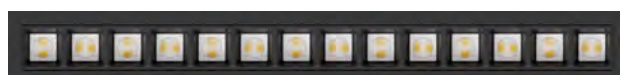

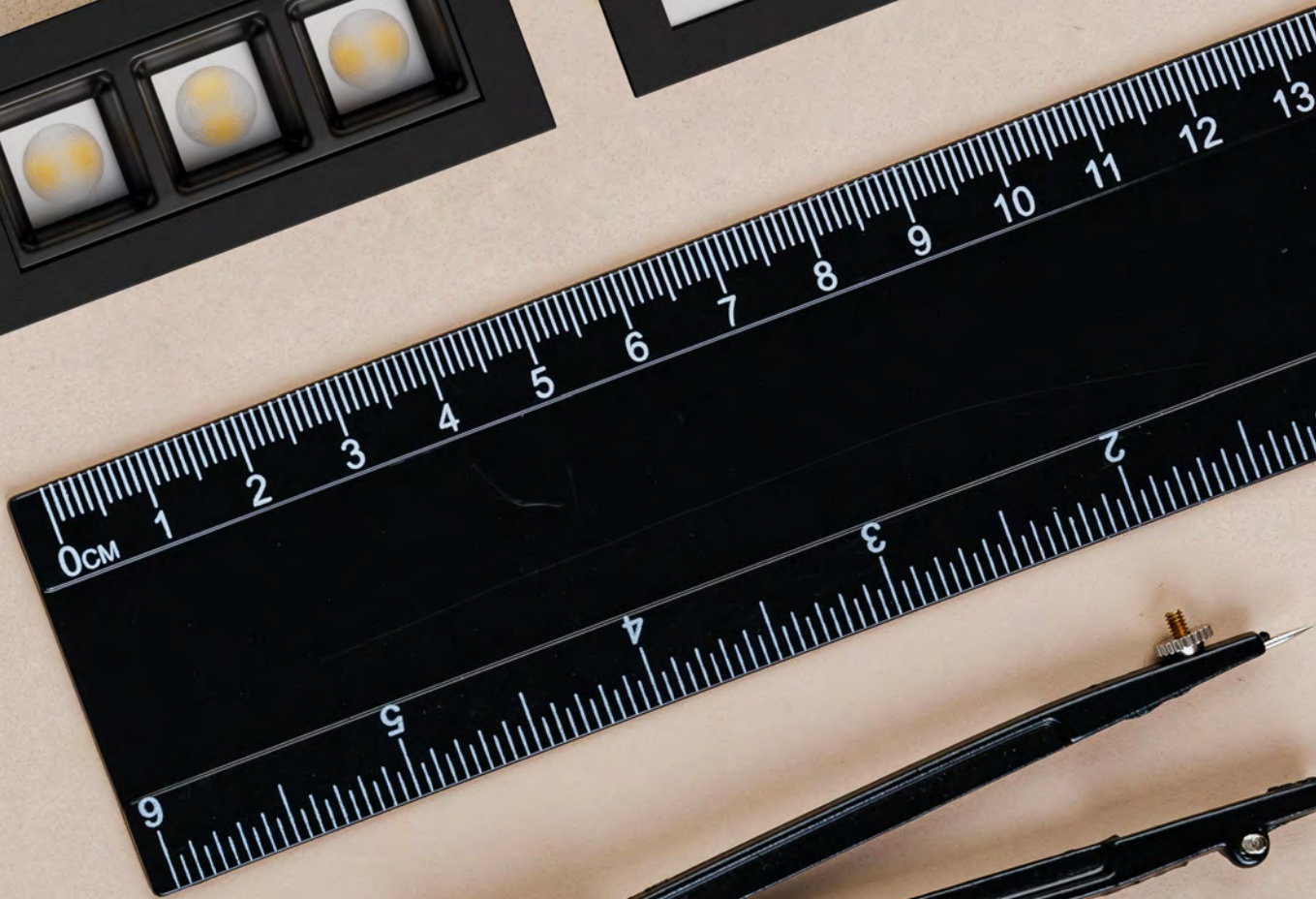
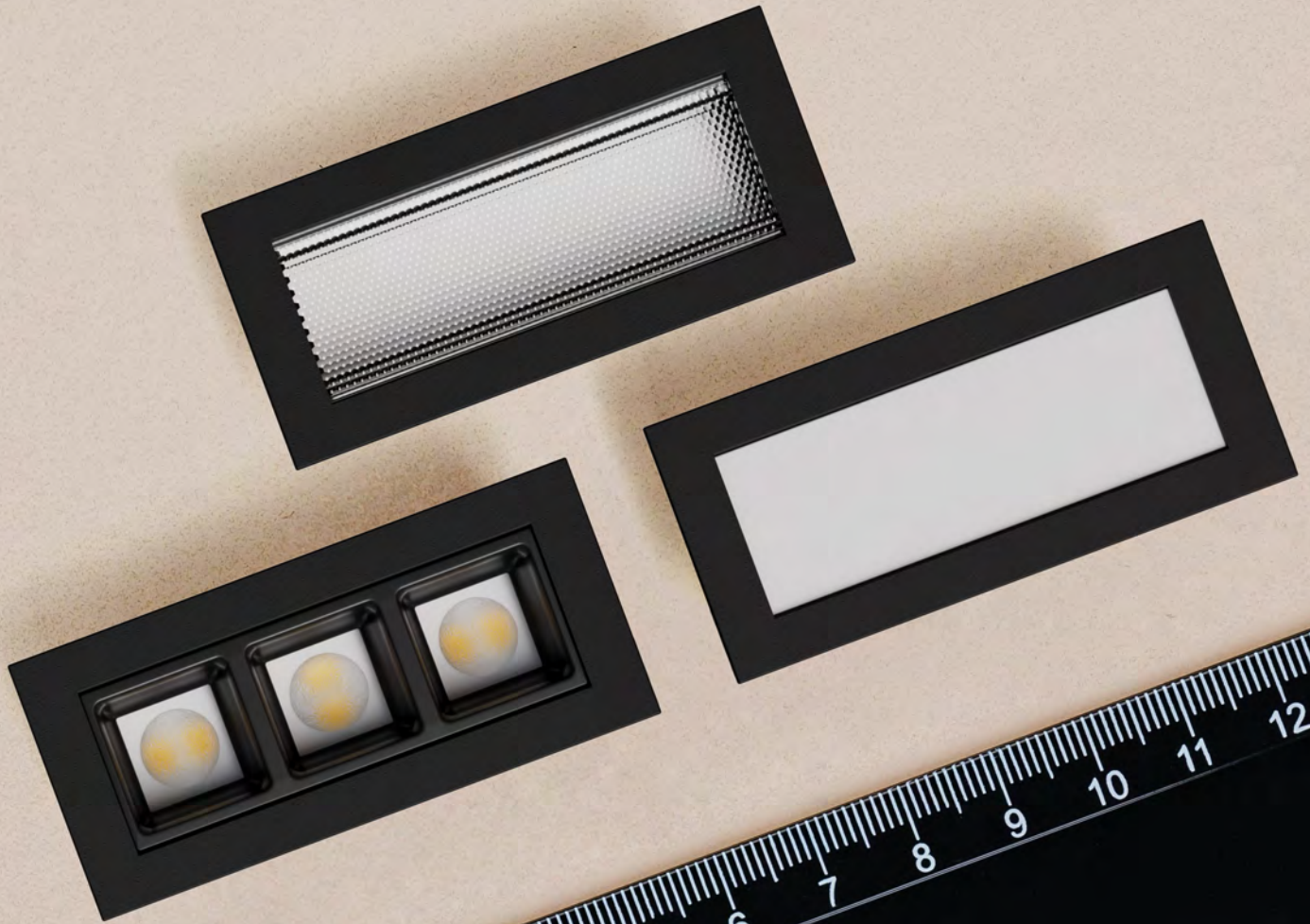



IT_ La riduzione dimensionale di MAYA_ MICRO si apprezza soprattutto sulla linea incassi. La gamma include apparecchi minimali, disponibili con bordo a vista oppure trimless, con diverse misure. Sull'intero programma si mantiene la possibilità di configurare apparecchi con ottiche, schermo microprismatico, oppure emissione diffusa. Spine metalliche di giunzione, gestite come accessorio, consentono l'unione di più incassi per ottenere lunghezze specifiche. Particolarmente apprezzabile la presenza delle versioni NANO, che assolvono ad impieghi particolari minimizzando al massimo la presenza del punto luce.

EN_ The dimensional reduction of MAYA_ MICRO is especially noticeable in the recess line. The range includes minimal devices, available with an exposed edge or trimless, in various sizes. The entire program maintains the ability to configure devices with optics, microprismatic screens, or diffuse emission. Metal junction, available as accessory, allow the joining of multiple recesses to achieve specific lengths. Particularly notable are the NANO versions, which are designed for specific uses, minimizing the presence of the light point as much as possible.



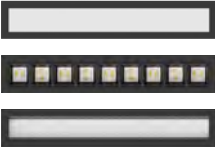
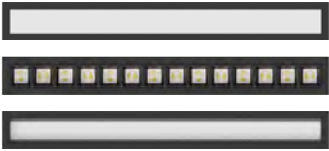

Incasso_Trimmed NANO

	Size	Power	Hole size (mm)			Dimension A	Lumen output	Code to complete *
			Width	Length	Depth			
	60	4 W	26	66	90	75 mm	504 lm	ZM-AA ■ ▲ □
	120	7 W	26	126	90	134 mm	882 lm	ZM-AB ■ ▲ □
	180	10 W	26	186	90	194 mm	1260 lm	ZM-AC ■ ▲ □
	300	5 W	26	286	90	295 mm	695 lm	ZM-AD ■ ▲ □

◆ Moduli SELV (V < 60 V) | IP40

UP to 139 lm/W | UP to UGR≥16 | L80/B20 80.000 h. | CRI>90 | UP to RG0 | SDCM<3
Lumen output values: luminaire luminous flux at 4000 K - optics 30°

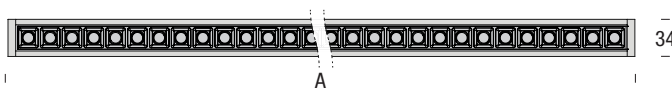
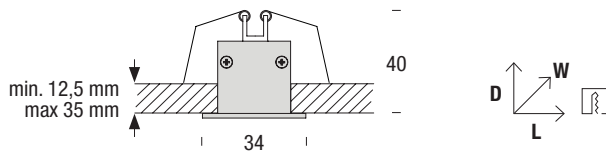

* Select your option

CCT	Optic	Structure colour
2700 K 1	30° Bianco A	Bianco WW
3000 K 2	30° Nero B	Nero BB
4000 K 3	55° Bianco C	
	55° Nero D	
	120° E	
	Micro M	

ALIMENTAZIONE REMOTA







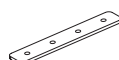





Description	Code to complete
Alimentatori	On/Off SLE0164
<input type="checkbox"/> 220-240Vac,	DALI/PUSH SLE0166

ACCESSORI

Description	Code
Staffa giunzione meccanica	ZSS03303



Incasso_Trimless NANO

Size	Power	Hole size (mm)			Dimension A	Lumen output	Code to complete *	
		Width	Length	Depth				
	60	4 W	28	68	30	60 mm	504 lm	ZM-BA ■ △ □
								
								
	120	7 W	28	128	30	120 mm	882 lm	ZM-BB ■ △ □
								
								
	180	10 W	28	188	30	180 mm	1260 lm	ZM-BC ■ △ □
								
								
	300	5 W	28	288	30	280 mm	695 lm	ZM-BD ■ △ □
								
								

Moduli SELV (V < 60 V) | IP40

UP to 139 lm/W | UP to UGR≥16 | L80/B20 80.000 h. | CRI>90 | UP to RG0 | SDCM<3
Lumen output values: luminaire luminous flux at 4000 K - optics 30°

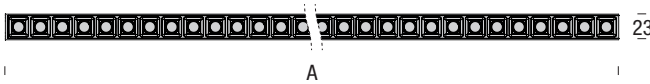
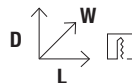
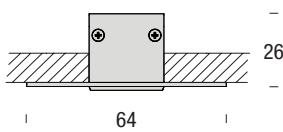

*** Select your option**

CCT	Optic	Structure colour
2700 K <u>1</u>	30° Bianco <u>A</u>	Bianco <u>WW</u>
3000 K <u>2</u>	30° Nero <u>B</u>	Nero <u>BB</u>
4000 K <u>3</u>	55° Bianco <u>C</u>	
	55° Nero <u>D</u>	
	120° <u>E</u>	
	Micro <u>M</u>	

ALIMENTAZIONE REMOTA

Description	Code to complete
Alimentatori	On/Off SLE0164
<input type="checkbox"/> 220-240Vac,	DALI/PUSH SLE0166

ACCESSORI

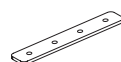

Description	Code
Staffa giunzione meccanica	ZSS03303

Incasso_Trimmed

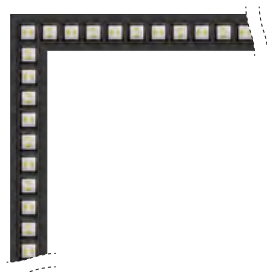
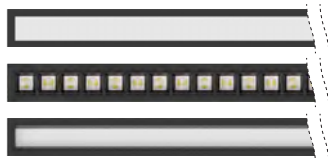
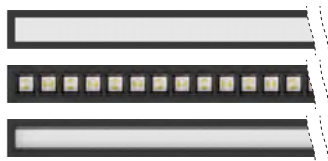

Size	Power	Hole size (mm)			Dimension A	Lumen output	Code to complete *
		Width	Length	Depth			
600	10 W	26	566	90	574 mm	1390 lm	ZM-AE ■ ▲ □

1100	20 W	26	1127	90	1133 mm	2780 lm	ZM-AG ■ ▲ □
-------------	------	----	------	----	---------	---------	--------------------

Size	Power	Hole size (mm)			Dimension	Lumen output	Code to complete *
		Width	Length	Depth			
600x600	20 W	26	...	90	Optic A 594 x B 573 120°/Micro A 585 x B 585	2780 lm	ZM-AM ■ ▲ □

◆ Moduli SELV (V < 60 V) | IP40

UP to 139 lm/W | UP to UGR≥16 | L80/B20 80.000 h. | CRI>90 | UP to RG0 | SDCM<3
Lumen output values: luminaire luminous flux at 4000 K - optics 30°

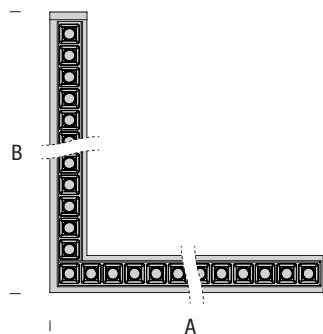
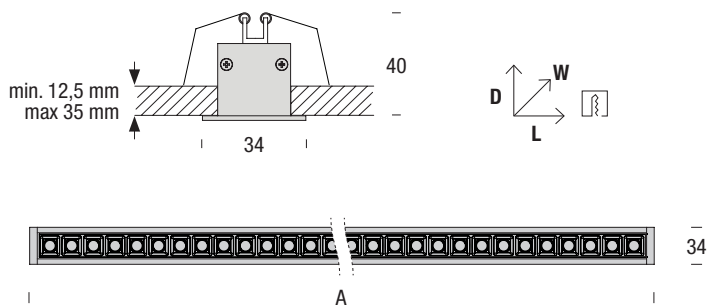

*** Select your option**

CCT	■	Optic	▲	Structure colour	□
2700 K	1	30° Bianco	A	Bianco	WW
3000 K	2	30° Nero	B	Nero	BB
4000 K	3	55° Bianco	C		
		55° Nero	D		
		120°	E		
		Micro	M		

ALIMENTAZIONE REMOTA

Description	Code to complete
Alimentatori	On/Off SLE0164
<input type="checkbox"/> 220-240Vac,	DALI/PUSH SLE0166

ACCESSORI

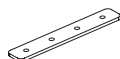

Description	Code
Staffa giunzione meccanica	ZSS03303

MAYA_MICRO

Incasso_Trimless

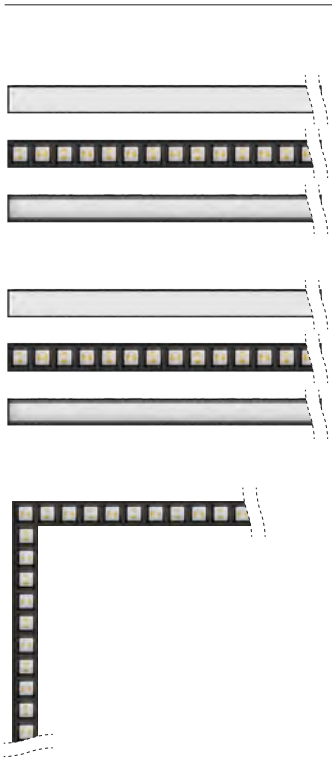

Size	Power	Hole size (mm)			Dimension A	Lumen output	Code to complete *
		Width	Length	Depth			
600	10 W	28	568	30	560 mm	1390 lm	ZM-BE <input type="checkbox"/> <input type="checkbox"/> <input type="checkbox"/>

1100	20 W	28	1125	30	1119 mm	2780 lm	ZM-BG <input type="checkbox"/> <input type="checkbox"/> <input type="checkbox"/>
------	------	----	------	----	---------	---------	--

Size	Power	Hole size (mm)			Dimension	Lumen output	Code to complete *
		Width	Length	Depth			
600x600	20 W	28	...	30	Optic A 579 x B 559 120°/Micro A 561 x B 561	2780 lm	ZM-BM <input type="checkbox"/> <input type="checkbox"/> <input type="checkbox"/>

Moduli SELV (V < 60 V) | IP40

UP to 139 lm/W | UP to UGR≥16 | L80/B20 80.000 h. | CRI>90 | UP to RG0 | SDCM<3
Lumen output values: luminaire luminous flux at 4000 K - optics 30°

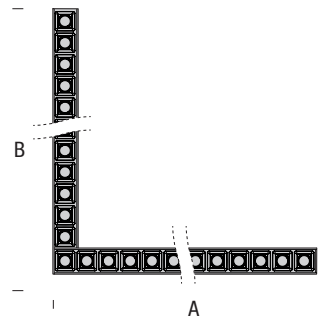
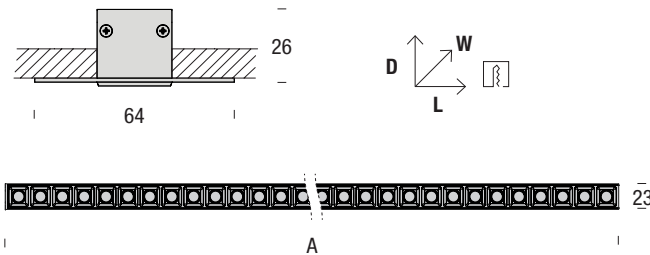

* Select your option

CCT	<input type="checkbox"/>	Optic	<input type="checkbox"/>	Structure colour	<input type="checkbox"/>
2700 K	1	30° Bianco	A	Bianco	WW
3000 K	2	30° Nero	B	Nero	BB
4000 K	3	55° Bianco	C		
		55° Nero	D		
		120°	E		
		Micro	M		

ALIMENTAZIONE REMOTA

Description	Code to complete
Alimentatori	On/Off SLE0164
<input type="checkbox"/> 220-240Vac,	DALI/PUSH SLE0166

ACCESSORI

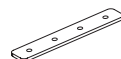

Description	Code
Staffa giunzione meccanica	ZSS03303

© 2024



PAN Srl
Via G. Michelucci 1
50028 Barberino Tavarnelle
Firenze, Italy

Information
Tel. +39 055 8059336
Fax +39 055 8059338
panint@panint.it
export@panint.it
panint.it



archiproducts®



8024598645957

