

Backlit Panel

BAC56140DM - 60 x 60 cm. - 36 W - 3000 K - UGR <19 / CRI > 90

DESCRIPTION

Backlit Panel is a latest generation LED fixture that stands out for its economy, luminous efficacy and reliability over time. The LED sources located on the back of the appliance emit light directly downwards to obtain the best performance in optimal operating conditions, making sources lifetime as longer as possible. Backlit can be installed as a recessed lighting panel for modular false ceilings or as pendant or ceiling mounted if matched with Modular System's boxes solutions.



Switch **1...10 / Push / DALI**

PRODUCTS CHARACTERISTICS

installation type	Light Panels
material	Extruded aluminum
Color	White
Power	36 W
Lumen output - Full emission	3105 lm
Efficacy	86 lm/W
Dimensions	60 x 60 cm.
net weight	1,8 kg.

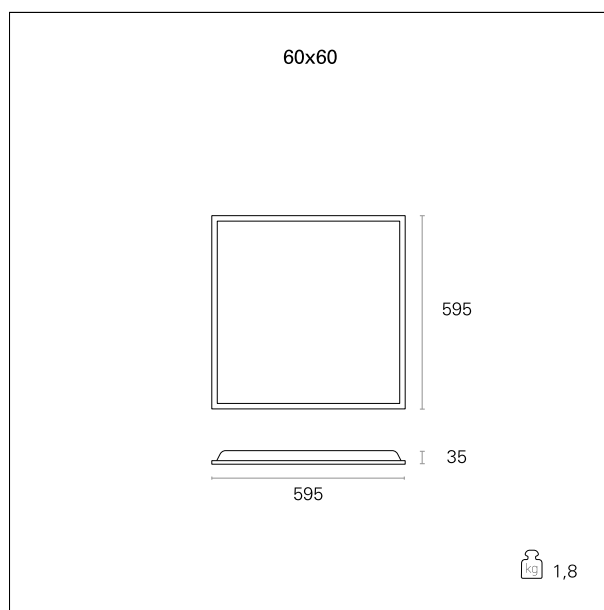

ELECTRICAL CHARACTERISTICS

feeding	220÷240 V
driver	1...10 / Push / DALI
Insulation class	Class II

MECHANICAL CHARACTERISTICS

product IP rate	IP20
IK	IK03

Backlit Panel

BAC56140DM - 60 x 60 cm. - 36 W - 3000 K - UGR <19 / CRI > 90

LED SOURCE DETAILS

led source type	SMD Led
Photobiological risk	RG 0 Exempt (IEC 62471)
Service lifetime	L80 / B20 - 50.000 h.
Light temperature	3000 K
CRI	CRI > 90

DRIVER CHARACTERISTICS

driver	1...10 / Push / DALI
--------	-----------------------------

LIGHTING DETAILS

Beam angle - direct	90°
UGR	< 19

PHOTOMETRIC

